



GT GOLF 2005-2013 to GT LIVE 2015 Update Instructions

WARNING: This update **ONLY** works on GT LIVE 2013 and older versions. The game must be registered, actively communicating and have licenses available on your operator account. Force a call in the ITNet menu (Connection Test>Force Call) to test communication.

If you have an older version of Golden Tee LIVE, call 800.262.0323 and press (1) for Technical Support.

IMPORTANT – PLEASE READ

- Golden Tee LIVE 2015 is **only** compatible with an approved video card. The use of any other video card may result in unreliable or unknown performance results. The update installer will not allow the update to execute if using unapproved video cards. For a list of approved video cards see Video Card Compatibility at <http://amusement.itsgames.com/service/manuals>.
- Complete a collection before starting. If a failure occurs, collection data may be lost.
- A Frequently Asked Questions sheet is included with your update shipment. An online version is available under Golden Tee LIVE 2015 at <http://amusement.itsgames.com/service/manuals>.

UPDATE CONTENTS:

- Update Memory Stick labeled *GT2005 - 13 to GL2015 V 10.04.XX P/N 7602503400*
- New 2015 Cabinet Marquee

Update Procedure

If your game is a 2013 move directly to Part 2. A Golden Tee 2013 will already have a sufficient amount of RAM.

NOTICE:

Although this Golden Tee LIVE update process is similar to previous updates, it may require replacing the DIMM, which will take additional time and tools to complete. Please read the enclosed instructions carefully before installation.

Follow the steps below in the exact order listed to prevent damage to the Nighthawk System Box.

Part 1: 1 GB Memory Upgrade Procedure

This step is only necessary if your game is 2012 and earlier. If your game is a 2013 it will already have 1 Gigabyte of memory and part 1 is not necessary.

SYSTEM REQUIREMENTS:

MUST HAVE 1 GIGABYTE (GB) OF MEMORY

To find the memory on your machine:

- Enter the Operator Setup Mode using the Setup button located on the coin vault. From the main menu, select **Trouble Shooting Shortcuts> System Tests> Hardware/Software> System Info**
- CPU Information line displays the amount of memory on the game. 1024 or 896 MB = 1 Gigabyte (No Memory Upgrade needed)

- CPU Information line displays 512 MB or 256 MB = Less than 1 Gigabyte (Memory Upgrade needed)

A video detailing these instructions is available via YouTube on IT's web site:

- RAM Card Installation - <http://www.youtube.com/watch?v=8VgrRMbb6rM>

WARNING: If your game is currently a GT 2012 you may not need to do step 1. If the 2012 system box has a serial number above 420000 you **do not** need to install the Memory Module (DIMM). Move on to Part 2.

See the image at right for the location of the six-digit serial number on your system box below the bar code.



Tools/equipment required for Memory Upgrade:

- 1 GB DIMM DDR2 style
- ¼-inch Hex Nut Driver (no longer than 9 inches)
- Standard/Flat Head Screwdriver
- Flashlight (optional)

1. Turn OFF all power to the cabinet.
2. Open the cabinet door housing the Nighthawk system box.

System Box

The Nighthawk System Box houses most of the game electronics and hardware in one box that can be easily installed. As with all electronic equipment, the system box should be handled with extreme care. Shock, severe temperature, or sudden impacts can damage the internal components that require costly repair.

Note: Be sure power to the cabinet is OFF when performing any of the procedures below. For added safety remove the power cord from the back of the cabinet (optional).

System Box Removal (Showpiece Cabinet)

- Unlock the control panel and open to expose the Nighthawk system box.
- Disconnect all connections to the system box. Be sure all wires and connectors are clear and out of the way. Label the connectors for easy reconnection.
- Loosen the 6 ¼-inch hex-head screws that secure the system box.
- Carefully lift the system box off the screws and up out of the cabinet.

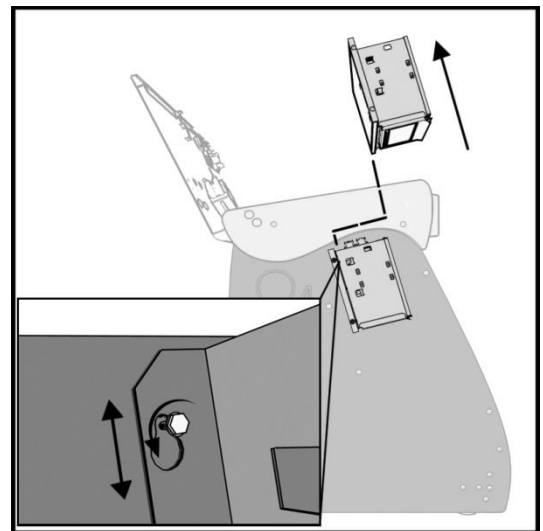

System Box (Dedicated Cabinet)

- It is not necessary to remove the system box from dedicated cabinets.

Note: The USB cables can connect to any of the USB ports on the back of the system box.

- Locate the three hex nut screws on the system box (below the warning sticker). Using a ¼-inch hex nut driver loosen the screws but do not remove them.
- Locate the three hex nut screws on the opposite side of the system box. Using a ¼-inch hex nut driver remove the screws and set them aside in a safe place.
- Using a standard head screwdriver remove the security labels on both sides of the system box. Please note that if the machine's service history includes a software or memory upgrade transaction, opening the system box will *not* void the warranty absent evidence of negligence.



WARNING: Electrostatic discharge (ESD) can damage components. To provide some ESD protection, wear an ESD wrist strap connected to the Nighthawk system box. Another method is to discharge yourself by touching the metal system box while your feet are flat on the ground before touching any components.

- Remove the top of the system box and locate the DIMM slots located adjacent to the fan.

Note: It is possible that the video card on your machine may sit on top of the thumb latch for the DIMM. If this is the case please see Video Card Removal on the last page of these instructions.



- Push down on the two white or beige thumb latches securing the DIMM on either side. Make sure the latches are pushed outward to the open position. **You must remove any and all DIMM before moving to Step 8.**

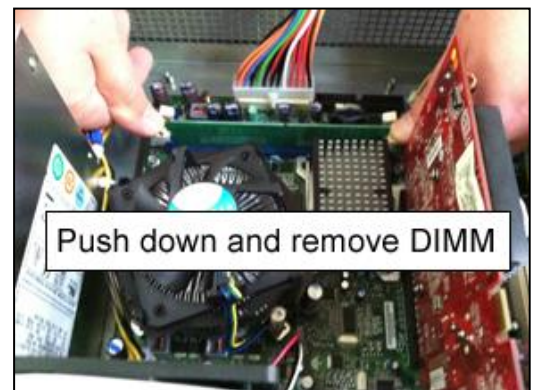

8. Carefully remove the new DIMM from its protective packaging. **Do not touch any part of the DIMM other than the sides of the card.**
9. Position the new DIMM into slot 0 (zero) on the motherboard. Align the small notch at the bottom edge of the DIMM with the key/slot in the socket. (The key/slot should prevent inserting the DIMM backwards.) Typically the bar code label faces away from the fan.

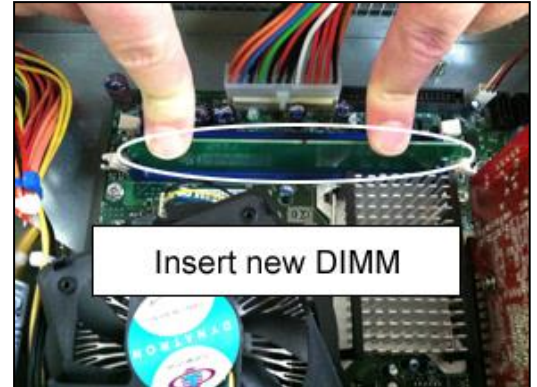

10. Insert the bottom edge of the DIMM into the socket. Push down on the top edge of the DIMM until the retaining thumb latches snap into place. **Do not force the DIMM into the slot.** Make sure the latches are firmly in place.
11. If the video card was removed, replace it.
12. Slide the top of the system box back in place.
13. Replace the three hex nuts on the top panel of the system box and tighten them.
14. Tighten the three hex nuts at the opposite side of the system box (below the warning sticker).
15. If you have a showpiece cabinet, reinstall the system box. See System Box Replacement below.
16. Turn ON the machine to ensure the new memory is recognized. Let the game boot up completely to the game mode.

Note: On boot up an Intel screen may appear indicating that an increase in memory occurred. Within a few seconds this screen will disappear and the game should continue to boot as expected. Proceed to Part 2: Install the Security Chip.

System Box Replacement (Showpiece)

- Unlock the control panel and open to expose the inside of the cabinet.
- Align the system box onto the 6 mounting screws of the internal slanted panel. The connection ports face up. Once the system box is in place, tighten the 6 ¼-inch hex-head screws to secure the box to the panel.
- Connect the required connections. See the Installation Manual and User Guide for more details.

Part 2: Update Procedure

Please remember it is important to **KEEP** the memory stick for future updates. The memory stick can be used for an unlimited number of updates. **DO NOT DISCARD.** Follow the steps below in order.

1. Access the system box on a showpiece style cabinet by turning the key at the back of the cabinet to unlock the control panel box and lift up the hinged control panel. On a dedicated upright cabinet unlock and remove the back door.
2. Turn off power to the system box or the entire cabinet.
3. Locate an open USB port on the system box. If there are no open ports, unplug the USB cable that is routed to the control panel.

WARNING: Do not unplug the USB cables routed to the I/O Board or CID.

4. Insert the Update Memory Stick into an open USB port on the system box.
5. Turn ON power. **It is important to prevent losing power or turning off the game during this software update!**
6. The game should automatically detect the memory update stick and run the Installer program. It is possible that on some systems the game might reboot again before running the Installer program.

WARNING: If Error Message 6 or 12 displays, or a blank screen after booting from stick, the wrong USB cable was disconnected. Turn OFF power, replace the cable, select a different USB port and try again. If the initial update speed is not ideal, more than one reboot may occur.

7. The Installer will read the CID, I/O Board, and Nighthawk system box to make sure this upgrade is possible. Watch the screen for instructions.
8. Press Start to connect to ITNet for authorization.
9. Press Start again to accept the ITNet Operator's Agreement (the installation of the software upgrade will begin). The upgrade will take about 30 minutes to complete and can take longer in some cases. Please be patient during this process.

Important! Do not lose power or turn off the game after the start button has been pressed or any time while the update is in progress.

During this update you will not see the graphic progress bar. It will be a wall of text as this is an operating system update.

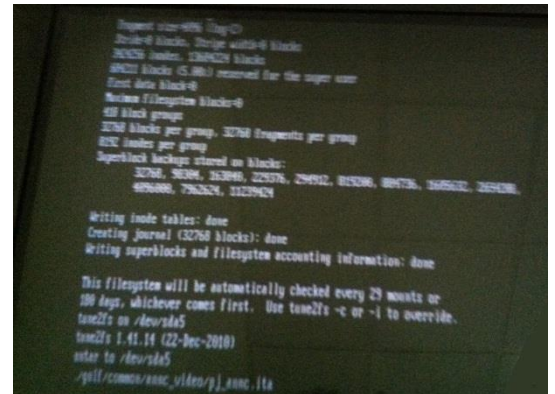

10. When the install is complete, the Installer prompts to turn OFF the game, remove the memory update stick, reconnect the original USB cable if removed, and then turn the game back ON.
11. Once the game is in the attract mode, enter the System Setup menus and verify that the software version is **10.04.XX**.

SETTING THE RESOLUTION

If the game is connected to an HDTV wide screen, be sure the resolution switches on the I/O Board are set for a wide screen. With a capable HDTV the proper settings are 1920x1080 (1080p) with the use of a Zotac 640 Video card and 1280x720 (720p) with any other approved video card (800x600 and 640x480 resolutions are only meant for Cathode Ray tube 4:3 aspect ratio monitors).

To check the resolution settings on your Golden Tee, enter the System Setup menus and choose Trouble Shooting Shortcuts. The current resolution displays at the lower left side of the screen. If using a wide screen TV and the resolution indicated is 800x600 or 640x480, it **must** be changed to *at least* 1280x720. Refer to the chart below.

HDTV MONITOR APPLICATION

RESOLUTION SETTINGS

<p>1 <input type="checkbox"/> 1280 x 720 (HDMI) 720p</p> <p>2 <input type="checkbox"/></p> <p>3 <input type="checkbox"/></p> <p>4 <input type="checkbox"/> OFF ON</p>	<p>1 <input type="checkbox"/> 1280 x 720 (SVGA) 720p</p> <p>2 <input type="checkbox"/></p> <p>3 <input type="checkbox"/></p> <p>4 <input type="checkbox"/> OFF ON</p>
<p>1 <input type="checkbox"/> 1280 x 720 (DVI-D) 720p</p> <p>2 <input type="checkbox"/></p> <p>3 <input type="checkbox"/></p> <p>4 <input type="checkbox"/> OFF ON</p>	<p>1 <input type="checkbox"/> 1920 x 1080 (HDMI) 1080p</p> <p>2 <input type="checkbox"/></p> <p>3 <input type="checkbox"/></p> <p>4 <input type="checkbox"/> OFF ON DEFAULT</p>

IMPORTANT NOTE

I/O CARD DIAGRAM FOR ORIENTATION



Sw201 Sw200 Sw202

OFF ON OFF ON OFF ON

Sw200 ALWAYS ON
Do Not Change
Settings shown for Showpiece

ADDITIONAL SETTINGS

<p>Primary Monitor</p> <p>1 <input type="checkbox"/> Primary Monitor has 16 x 9 Aspect Ratio</p> <p>2 <input type="checkbox"/> DEFAULT</p> <p>3 <input type="checkbox"/></p> <p>4 <input type="checkbox"/> OFF ON</p>	<p>Secondary Monitor</p> <p>1 <input type="checkbox"/> Optional 2nd Monitor has 16 x 9 aspect ratio</p> <p>2 <input type="checkbox"/> DEFAULT</p> <p>3 <input type="checkbox"/></p> <p>4 <input type="checkbox"/> OFF ON</p>
<p>System Setup</p> <p>1 <input type="checkbox"/> Enter System Setup Menus</p> <p>2 <input type="checkbox"/></p> <p>3 <input type="checkbox"/></p> <p>4 <input type="checkbox"/> OFF ON</p>	<p>1 <input type="checkbox"/> Do Not Flip Optional 2nd Monitor</p> <p>2 <input type="checkbox"/> DEFAULT</p> <p>3 <input type="checkbox"/></p> <p>4 <input type="checkbox"/> OFF ON</p>
<p>1 <input type="checkbox"/> Exit System Setup Menus</p> <p>2 <input type="checkbox"/> DEFAULT</p> <p>3 <input type="checkbox"/></p> <p>4 <input type="checkbox"/> OFF ON</p>	<p>1 <input type="checkbox"/> Vertical Flip Optional 2nd Monitor</p> <p>2 <input type="checkbox"/></p> <p>3 <input type="checkbox"/></p> <p>4 <input type="checkbox"/> OFF ON</p>

Note: In the Additional Settings above, ONLY the ON switch matters for correct setup and operation.



Showpiece Marquee Installation

1. Slide the rectangular marquee mounting frame from its position on the two upright posts (if an old marquee exists)
2. Remove any one of the four side pieces of the mounting frame.
3. Remove the current plastic laminate marquee from the mounting frame (if necessary), but do not remove the cardboard.
4. Slide the updated marquee into place and reassemble the side piece or pieces. Make sure all of the surrounding pieces of the mounting frame are tight and the plastic laminate is smooth against the cardboard.
5. Slide the fully assembled marquee back into position.

System Box Filter Cleaning

A clean filter is very important for proper cooling and optimal performance of the hardware. Be sure to clean this filter regularly.

1. With the back door removed, slide out the ventilation filter located on the underside of the system box.
2. Thoroughly clean the filter so it is free of dust and debris.
3. Insert the filter back into the slots of the bracket located on the underside of the system box.

Video Card Removal

Only follow these instructions if the video card in your system box interferes with the removal of the Dual in-line Memory Module (DIMM).

1. Disconnect the ribbon cable from the motherboard and clear it from the video card. Note the orientation. If applicable, remove the black and orange cable from the video card.
2. Remove the ¼-inch screw holding the card to the system box and set aside. See Video Card Screw.

Video Card Screw

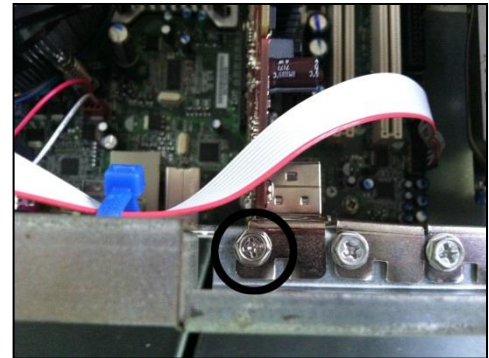

3. Carefully remove the video card, touching it only on the edges, and set it in a safe spot away from liquids, dust or debris. There are two types of plastic mounting clips used in the system box: push clip (white or beige) and swing clip (black or brown). Depending on the year of your system box you may have either a push clip or a swing clip. See images below for releasing each type of clip.

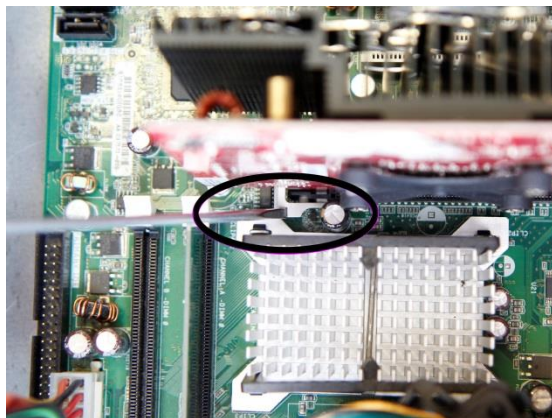

Push Clip – Use a screwdriver to push down on the clip and release the video card.

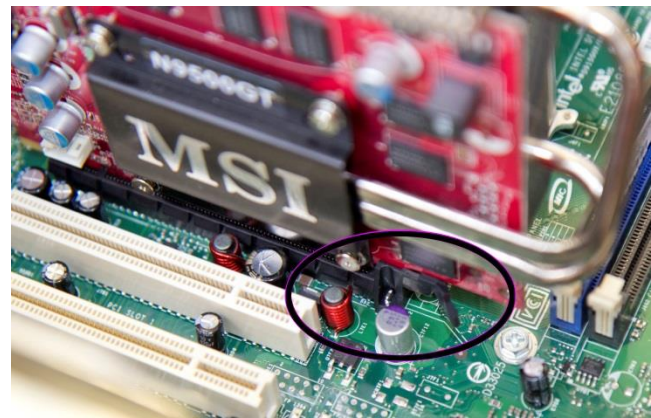

Swing Clip – Use a screwdriver or your finger to swing the clip aside and release the video card.

4. After replacing the DIMM as outlined on page 3, reinsert the video card by lining up the edge of the video card to the connector on the motherboard. Press until it is firmly seated. Be sure both sides are inside the connector and the locking clip is engaged.
5. Reattach the video card to the system box using the ¼-inch hex nuts.
6. Reattach the ribbon cable. Be sure it is connected to all pins. If necessary, reattach the orange and black cable to the video card.