



DEDICATED CABINET USER MANUAL
&
KIT INSTALLATION MANUAL

Version 01/08



WARNINGS AND NOTICES

NOTICE

This game is intended to be operated for amusement purposes only. It is not to be operated in violation of any federal, state, or local laws or regulations. As the owner and/or operator of this game you are responsible for its operation in compliance with such laws and regulations. The factory settings for this game may require adjustment in order to comply with the laws and/or regulations in the jurisdiction where the game is located. It is the sole responsibility of the operator to determine what laws and/or regulations are applicable and to make any adjustments to the game before operating it for its intended purpose.

NOTICE

This manual and the information contained within is subject to change without notice.

WARNING

Use of unauthorized parts or making any unauthorized modifications will void the warranty and may result in the game operating in an unsafe or incorrect manner.

WARRANTY, REPAIR, AND RETURN POLICY

- 90-day warranty on all electronic components. All warranty periods begin on the date of purchase from Incredible Technologies, Inc.
- There is a minimum \$55.00 service charge for all non-warranty repairs or returns.
- For all servicing, return to Incredible Technologies, Inc.
- ANY non-factory repair or attempted repair voids warranty.

RETURN MERCHANDISE AUTHORIZATION

- All returned merchandise must have a Return Merchandise Authorization (RMA) number marked clearly on the outside of the package.
- You must obtain all RMA numbers from Incredible Technologies. Please have the product's Cabinet Identification Device number available when calling for an RMA number.
- Merchandise returned without an RMA number will not be accepted.
- Warranty may be void if serial number or security labels are tampered with or removed. **Opening the Nighthawk Chassis system will void your warranty.**
- Advance replacement hardware will be shipped to the customer address on file unless specified otherwise.
- Advance replacement hardware will be billed to the customer until Incredible Technologies, Inc. receives the returned merchandise, at which time a credit will be issued.
- All repairs and/or replacements will ship as soon as possible after receipt or request (subject to availability).

If the original purchaser discovers any physical defect in the media (disk, EPROM, tape) on which the software is distributed or in the documentation, which in the opinion of Incredible Technologies, Inc. (IT) prevents the product from being used as reasonably intended, IT will replace the media or documentation at no charge. The purchaser must return the item to be replaced, with proof of purchase, to IT within 90 days after taking delivery of the software.

IT warrants to the original purchaser that the hardware product is in good working condition for a period of 90 days from taking delivery of the product. Should this product, in IT's opinion, malfunction within the warranty period because of a defect in design, materials, or workmanship, IT will repair or replace this product without charge under the terms as follows. Replacement of either the hardware product or its component parts will be only on an exchange basis. Any replaced parts or components become the property of IT. This warranty does not apply to those products that have been damaged due to accident, abuse, improper installation, natural disaster, or unauthorized repairs or modifications.

IT excludes any and all implied warranties, including warranties of merchantability and fitness for a particular purpose, and limits the purchaser's remedy to returning the software, hardware, or documentation to IT for replacement.

IT makes no warranty or representation, either express or implied, with respect to this software, hardware, or documentation, their quality, performance, merchantability, or fitness for a particular purpose. This software, hardware, and documentation are licensed "as is," and the purchaser/licensee assumes the entire risk as to their quality and performance.

In no event will IT be liable for direct, indirect, special, incidental, or consequential damages arising out of the use or inability to use the software, hardware, or documentation, even if advised of the possibility of such damages. The warranty and remedies set forth above are exclusive and in lieu of all others, oral or written, express or implied. No person, seller, dealer, agent, or employee is authorized to make any modification or addition to this limited warranty.

Some states do not allow the exclusion of implied warranties or liability for incidental or consequential damages, so the above limitation or exclusion may not apply to you. This warranty gives you specific legal rights, and you may also have other rights that vary from state to state.

- INCREDIBLE TECHNOLOGIES, INC

TARGET TOSS PRO: BAGS™, SILVER STRIKE BOWLING™, GOLDEN TEE LIVE®, ITS®, INCREDIBLE TECHNOLOGIES®, IT®, ITNet®, and IT incredible TECHNOLOGIES® are the properties of Incredible Technologies, Inc. All Rights Reserved.

© Copyright 2007-2008 Incredible Technologies, Inc. All Rights Reserved. Unauthorized duplication is a violation of applicable law.

All other marks are the properties of their respective owners. All rights reserved.



DEDICATED AND KIT INSTALLATION MANUAL

TABLE OF CONTENTS

TABLE OF CONTENTS	1
DEDICATED CABINET	4
Dedicated Cabinet Contents	4
Leg Leveler Installation and Adjustment	4
Apply Power	4
General Cabinet Maintenance.....	5
Dedicated Cabinet Repair Procedures.....	6
System Box	6
I/O Board.....	7
Cabinet Identification Device (CID).....	7
Cash Vault.....	8
Control Panel.....	9
Cabinet Bezel.....	11
Lighted Marquee.....	11
Fluorescent Light Fixture	11
Speakers.....	12
Monitor.....	12
I/O Dip Switch Settings	12
KIT INSTALLATION.....	15
Kit Contents.....	15
Recommended Tools.....	15
Installation Preparation.....	16
Preparing The Cabinet.....	16
Cabinet Selection	16
Preparing the Cabinet for Installation	16
Electronics Installation.....	19
Install Nighthawk System box	19
Install Cabinet Identification Device (CID)	19
Install I/O Board.....	20
Control Panel Installation	20
Install Optional Control Panel for Existing I.T. Cabinets.....	20
Trackball and Button Preparation (For Most Kits).....	21
Control Panel Overlay Installation.....	22
Finishing The Control Panel.....	23
Complete System Box Connections.....	24
Attach I/O Power, Audio, and USB cables.....	24
Attach Main Video Cable	24
Attach Power Cable	24
Complete I/O Board Connections.....	25
Connect JAMMA Harness.....	25

Connect the Control Panel Switches and Cable	25
Connect Coin Door Lamps	25
Connect the Trackball	25
Connect Audio Cables	25
Connect the USB Cable	25
Connect Medium or Low Resolution Monitor	25
Connect VGA or SVGA Monitor	25
Connect I/O Power Cable	25
Check All Connections.....	25
Cabinet Graphics Installation.....	26
Side Decal Installation.....	26
Marquee Installation	26
Final Connections.....	27
Coin Doors, Test Switch, and Volume Controls	27
Initial Power-Up.....	27
SYSTEM SETUP MENUS	28
Main Menu	28
Collections & Earnings Menu.....	29
Do Collection.....	29
General Settings.....	30
Operator Adjustables.....	31
General Adjustments	31
Money Slot Adjustments	32
Sound Adjustments	32
Collection Settings.....	33
Reset to Factory Settings.....	34
System Tests	35
Video Tests	35
Color Adjustments	36
Contrast Adjustments	36
Screen Size Adjustment.....	36
Sound Tests.....	37
Player Control Tests.....	37
Mechanical Meter Test	37
Hardware Tests.....	38
Hardware/Software.....	38
Check Hard Drive.....	39
Check Cooling.....	39
Troubleshooting Shortcuts.....	40
Target Toss Pro Settings & Audits	40
Player Cost Schedule	41
Game Audits.....	41
Game Options	42
Reset Leaderboards.....	42
TROUBLESHOOTING & REFERENCE	43
APPENDIX A Troubleshooting GUIDE	43
APPENDIX B JAMMA, Trackball, and I/O Power Connections	47
APPENDIX C Replacement Part Numbers	48
APPENDIX D Nighthawk Component Diagrams.....	49
APPENDIX E GNU General Public License.....	55
APPENDIX F Menu Navigation Shortcuts.....	57
Game Icon Descriptions.....	57
APPENDIX G Mounting Templates	58
Trackball Orientation Diagram	58
Trackball Mounting Template.....	59
Button Templates	61



NOTE

PLEASE RETAIN ORIGINAL SHIPPING BOX FOR SERVICE AND REPAIR.

The Target Toss Pro: Bags KIT is designed for use in cabinets with a JAMMA cable and wiring installed.

If you do not have a JAMMA harness already installed in the cabinet you have selected and are wiring the cabinet yourself, refer to the JAMMA Wiring Diagram in Appendix B.

Do NOT perform any installation or repair when the cabinet is powered on. Make sure the cabinet is unplugged from all power sources before and during installation.

Some game features may not be allowed in certain state or local jurisdictions. Be sure to check your local laws before activating or allowing any features that may be questionable in your area. Adjust game settings from the System Setup Menus. Refer to this manual for details.



DEDICATED CABINET

Congratulations on purchasing a Target Toss Pro: Bags Dedicated Cabinet. The game comes complete and ready to plug in and start earning money.

DEDICATED CABINET CONTENTS

(1) Target Toss Pro: Bags Dedicated Cabinet

Shipped inside the coin tray:

(1) Power Cord

(2) Rear Leg Levelers

Shipped inside the vinyl pocket attached to the inside of the back door:

(1) Target Toss Pro: Bags Manual

(1) Monitor Manual

(1) DBV/Coin Door Manual and Extra Parts

(1) T-15 Torx Tamper-Resistant Wrench

(1) T-20 Torx Tamper-Resistant Wrench

(1) T-25 Torx Tamper-Resistant Wrench

(2) ¼-20x16 Bolts for Marquee Header

LEG LEVELER INSTALLATION AND ADJUSTMENT

Once your game is in position at the location, it is necessary to install and adjust the leg levelers. The leg levelers will help stabilize the game on an uneven floor, and help it from moving or shifting during game play. The game is shipped with the two front leg levelers installed. You will need 2 people to install the rear leg levelers. One person must carefully tip the game either forward or to one side to expose the threaded inserts located on the bottom rear of the cabinet. While tipped up, carefully thread the leg levelers into place. Adjust the levelers as necessary to level and stabilize the game.

APPLY POWER

Locate the power cord, shipped inside the coin door. Connect the power cable to the plug on the back of the cabinet, then plug the cable into a 3-pronged, grounded wall socket. Locate the power switch on the back of the cabinet and turn it on.

Watch the game carefully when you first turn it on. Look and smell for smoke (TURN IT OFF IMMEDIATELY IF ANY IS NOTICED). Make sure the fan inside the system box is running and the LED's on the I/O board in back are flashing. If not, something is wrong, turn off the game.

Check the Cabinet ID Device (CID) Number

Watch the screen during boot-up and wait for a red verification screen to appear. Note the Cabinet ID Number (CID) that appears on this screen, and verify that it matches the CID number printed on the back of the cabinet. The screen will automatically time out and boot-up will continue.

Check the Coin Switch and Bill Validator

Try the coin switch. Drop quarters or tokens through to check the coin mech. Insert a dollar bill into the bill validator and listen for the credits to ring up. Make sure the game is adding credits and the correct quantity. You can use the PLAYER CONTROL TEST by pressing the System Setup button inside the coin door and entering the SYSTEM TESTS MENU. Make sure all of the controls work.

System Temperature

The state of the art Nighthawk hardware is extremely powerful, and therefore generates a substantial amount of heat. Measures have been taken to keep the various components cool during normal use. If overheating occurs, game play and hardware longevity may be affected. Refer to "General Cabinet Maintenance- Care and Cleaning of Cooling Fans and Vents" for instructions on maintaining optimal performance of the system. Use the Check Cooling menu in the System Setup menus to monitor the available temperatures within your system. Enter System Setup by pressing the System Setup button inside the outer door of the coin vault. Once at the main System Setup menu, use the trackball and Start button to select *Troubleshooting/Info*, then *Check Cooling*.

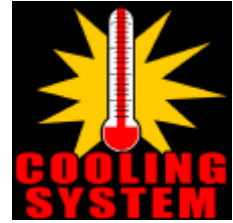

Custom Adjustments

Upon initial power-up, the game will initialize to factory default settings. These settings affect game elements such as number of credits per coin, volume control, etc. The System Setup section will describe how to alter these settings and view the system audits or run system tests.

GENERAL CABINET MAINTENANCE

Games that are in good working condition, with clear monitors, clean control panels and working trackballs will make more money than a machine in poor condition. It is definitely worth your time and attention to protect your investment with a little common care. Each week, clean the 27" monitor and wipe down the control panel to bring back that new game look. Test the trackball and buttons regularly to make sure they are playing properly. And perhaps most important, make sure the coin mechs and bill acceptors are in good working order.

Care and Cleaning of Rubber Bumper

The rubber bumper on the front of the cabinet's control panel is made from durable nitrile rubber. Clean it using a mild soap and water solution or Windex.

Trackball Maintenance

The trackball will require periodic maintenance to assure optimum performance. In most cases the inside of the trackball simply needs to be cleaned of any accumulated dust and debris.

To access the inside of the trackball, remove the 6 Phillips head screws that hold the trackball together and remove the top cover. Clean out any dust and debris inside the trackball. Polish the rollers and remove any foreign material that may be on the rollers. Do not lubricate the bearings, as this will only attract more dust. If the bearings do not spin freely it is best to replace the bearing assembly. Inspect the rollers for any nicks that may cause poor performance and replace if needed. Inspect the ball for any nicks and replace if needed. Parts can be obtained from Happ Controls and is an economical option rather than replacing the entire trackball assembly.

It is critical that the green field ground wire be properly connected to field ground. This prevents the trackball from building a static charge that can cause the game to lock up or reset. A static discharge can also damage the trackball's electronic components, as well as the main system.

Care and Cleaning of Cooling Fans and Vents

The hardware that runs Target Toss Pro: Bags is quite sophisticated, and many of the chips and processors will get hot very quickly. Like your desktop PC, the Target Toss Pro: Bags hardware needs adequate ventilation to work properly. Dust and dirt can be a major cause to overheating and will lead to costly repairs. At least once a month, check to make sure the cabinet and system box fans are working and free of dust and debris. Use a vacuum to clear all the ventilation holes on the cabinet at this time as well.

DEDICATED CABINET REPAIR PROCEDURES

SYSTEM BOX

The Nighthawk System box houses most of the game electronics and hardware in one box that can be easily installed. As with all electronic equipment, the system box should be handled with extreme care. Shock, severe temperature, or sudden impacts can damage the internal components that require costly repair.

Note! Turn off power to the cabinet when performing any of the following.

System Box Removal

1. Disconnect all connections to the system box. Be sure all wires and connectors are clear and out of the way. Label the connectors for easy reconnection.
2. Loosen the wood screws that secure the system box to the cabinet's floor.
3. Slide the system box toward you to align the screws in the key ways and lift the system box out of the cabinet.

System Box Installation

1. Align the system box onto the wood screws and slide it away from you so the screws are again located in the narrow part of the keyways. Tighten the screws to secure the system box.
2. Connect the required connections. See the Connections Diagram in Appendix B for more details.

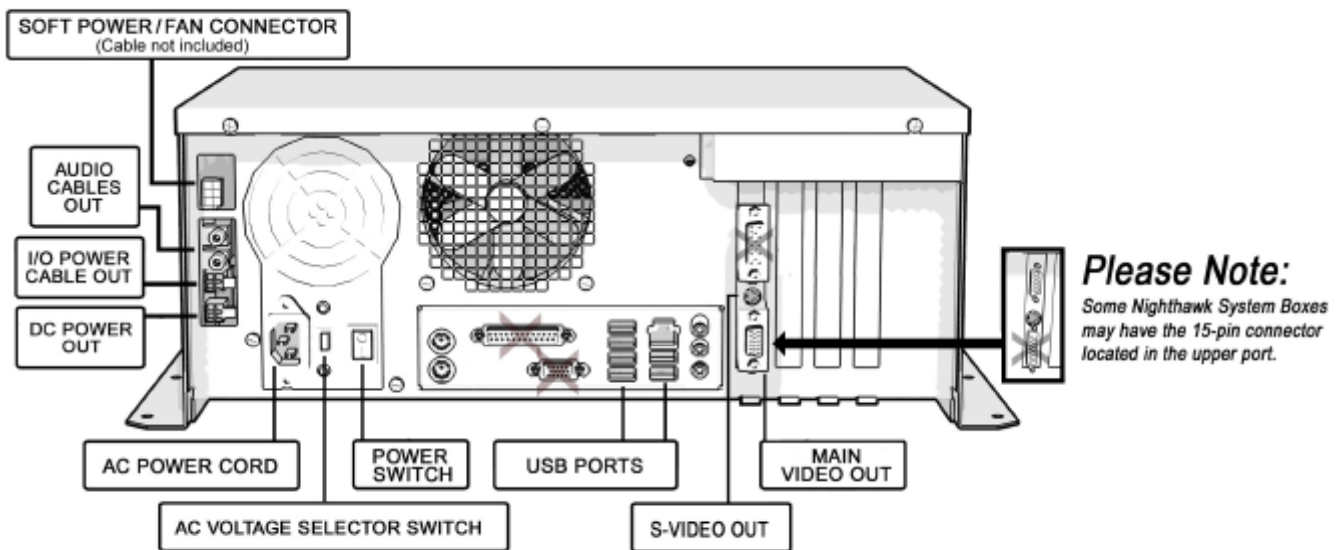

I/O BOARD

NOTE! The I/O board is game title specific and is not interchangeable with other game titles produced by Incredible Technologies on this system. Dedicated and Retrofit Kit I/O boards are different and are not interchangeable.

Dedicated I/O Board Removal

First, disconnect all connections from the I/O board. Refer to the I/O board connections diagram below. Label the connectors for easy reconnection and move them safely out of the way. Next, remove the four ¼" wood screws that secure the board to the left inside wall of the cabinet. Carefully remove the I/O board from the cabinet.

Dedicated I/O Board Installation

Place the I/O board in the proper location inside the cabinet. Be sure it is oriented properly so the cables reach the board. Secure the I/O board to the side of the cabinet with the four ¼" wood screws. Use the same mounting holes if at all possible. Be sure the board does not "bow" or is not stressed in any way. Once mounted, connect the appropriate connectors. Refer to the Dedicated I/O board connection diagram below.

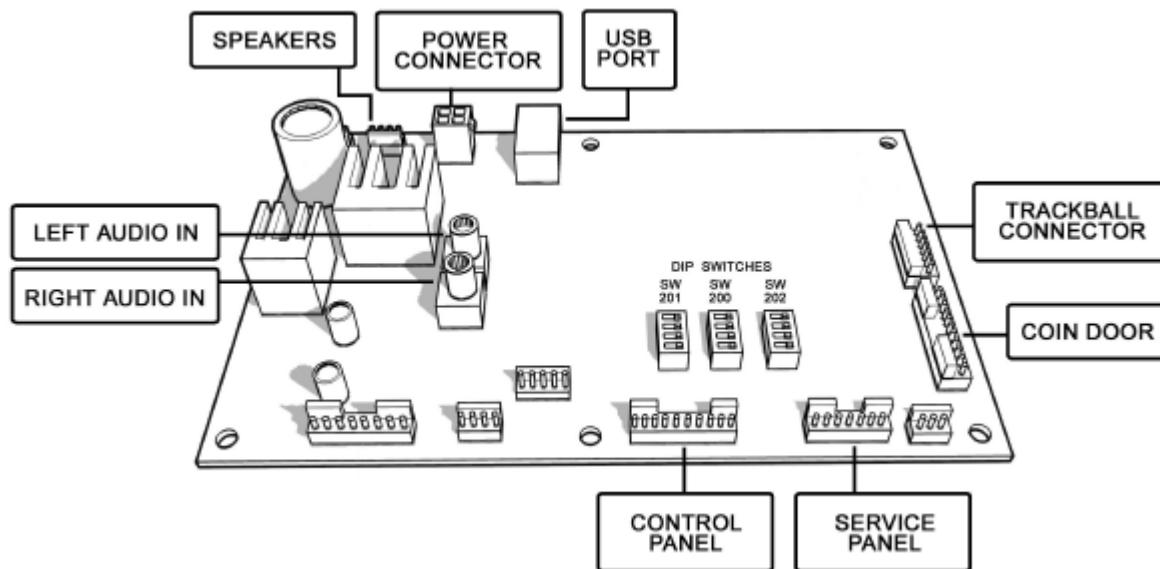

CABINET IDENTIFICATION DEVICE (CID)

This device contains a specific ID number that identifies your cabinet. The CID is a permanent number and must be connected to the main system box via the USB cable and working properly in order for the game to operate.

CID Removal and Replacement

If for some reason you must replace the CID, disconnect the USB cable from the CID. This is the only connection to the CID. Next, remove the two ¼" wood screws that secure the CID to the right inside of the cabinet.

To install a CID, reverse the order above.

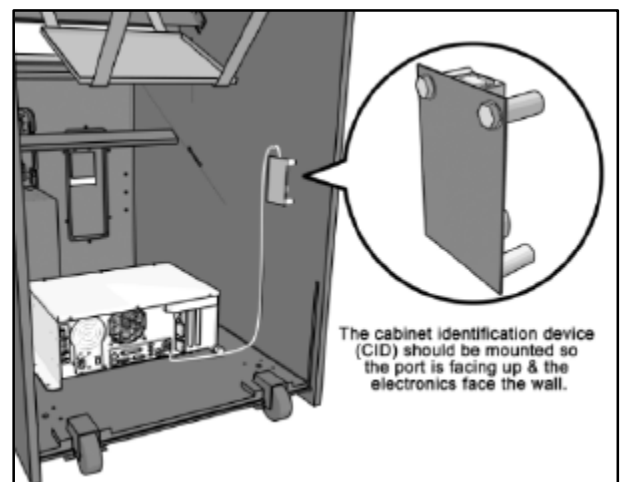

Note! The Cabinet Identification Device should **NEVER** be removed from the cabinet, even when replacing any of the other components. The CID is the cabinet's PERMANENT Identifier, regardless of any other components.

CASH VAULT

The Cash Vault has been designed for optimal security. With the double-locking doors, service technicians can read meters and enter System Setup mode with no access to the cash box.

Cash Vault Removal and Replacement

- 1) Unlock and open the outer door of the Cash Vault.
- 2) Using a T-15 Torx wrench, unscrew the card reader/button plate located on the right side by removing the four #8-32 screws located at the top and bottom of the plate.
- 3) Unplug the cable from the card reader, and disconnect the connectors for the coin meter and buttons.
- 4) Remove the plate and set it aside.
- 5) Remove the coin bin and the bill validator magazine to make it easier to work inside the vault.
- 6) Unplug the bill validator cables, and push the cables for the bill validator, card reader, buttons, and coin meter through the 2 holes located in the back of the vault.
- 7) The Cash Vault is attached by upper and lower locking brackets. These are each attached with two socket-head screws located within the vault.
- 8) Locate the socket-head screws on the top and bottom locking brackets. Remove the two bottom screws using a 9/64" hex key and remove the bottom-locking bracket. Make sure to note how it was installed.
- 9) Remove the two top screws and remove the top locking bracket, again noting how it was installed.
- 10) You can now pull the entire vault assembly out from the front of the cabinet. The vault is attached with foam tape, so it will need to be pried out or pushed from behind to loosen the adhesive.
- 11) Reverse the procedure to install the new door.

Locks

The outer lock is a secure T-handle lock, commonly used in vending. To open, insert the key and turn it clockwise until the lock-handle pops out. Next, rotate the lock-handle clockwise 90 degrees to open the outer door.

The inner door has a lock installed above the System Setup button. This lock is unlocked by turning the key 90 degrees clockwise.

Volume and Service Buttons

Mounted inside the outer door are controls for Volume and System Setup. Press the Volume Up button to increase the loudness of the sounds on the game, and press the Volume Down button to make your game quieter. Press the System Setup button to access the game's software menu system. The System Setup menus cover a variety of important areas including collections, tests, game adjustments, and optional settings. System Setup is covered in detail later in this manual.

Bill Acceptor

The dedicated cabinet ships with a MARS AE2681 D5 bill acceptor and is mounted on the cash vault door. The default dipswitch settings for this acceptor are ON = 1 – 3,6,7 and OFF = 4,5,8.

Bill Acceptor Removal

Disconnect the cable to the bill acceptor. Remove the four 11/32" sized nuts from the mounting studs. Disconnect the ground wire from the one lower stud. Then gently pull the acceptor off the studs from the back side of the coin door.

Bill Acceptor Installation

From the back side of the coin door, place the bill acceptor onto the four mounting studs. The faceplate will protrude out the front of the coin door. Place the field ground wire on a lower stud, and install the four 11/32" sized nuts on the mounting studs and tighten. Next connect bill acceptor cable in the cabinet to the mating cable on the bill acceptor itself.

Stacker Removal

A blue slide switch is located at the bottom of the stacker. Engaging it allows the stacker to be removed.

Coin Mech

Coin Mech Removal

Loosen the two finger screws to release the securing braces. Slide the upper brace upward, and the lower brace downward. The mechanism should pull straight out.

Meter

This 5-volt device is mounted behind the card reader plate next to the inner door of the coin vault. One lead of the meter is connected to a +5 volt source and the other lead is connected to the appropriate signal wire. See wiring diagram in Appendix D. An additional opening is available just below the meter, if a second meter is desired.

CONTROL PANEL

Opening the control panel provides access to the trackball and buttons, as well as the controls for adjusting both color monitors. To open the control panel, locate and remove the two T-25 security screws on either side of the cabinet. A T-25 Torx wrench has been provided in the vinyl pocket on the back door. Remove the screws completely before opening the control panel. Once the screws have been removed, store them in a safe place and then lift the hinged control panel from the top, where the control panel meets the plastic bezel.

Monitor Adjustments

There is a small board located beneath the control panel that are used to adjust your monitors. This control is placed here so you can view the monitor when making corrections to color, brightness or size. Use the Monitor Test screens in System Setup for best results.

Software Update Connections

A power cord and USB connector are supplied under the control panel, in anticipation of software updates via a DVD drive. When a software update is available, you can conveniently connect your compatible DVD drive with no additional equipment needed.

Note!

Some DVD drives do not have a mating AC power connector and will require an alternative AC power source.

Soft Power Switch (cable not included)

A “soft power” switch has been added beneath the control panel, to assist in the update process. This switch will turn off power to the cabinet so you don’t have to reach around to the main power switch located on the back of the cabinet.

Note!

If you turn power off using the Soft Power Switch, you **must** use this same switch when turning power back on.

Trackball Replacement

To replace a trackball, open the control panel and remove the 4 long screws holding the trackball in place. Be careful not to lose any of the screws, washers and lock washers. Disconnect the wire harness and ground wire and remove the old trackball. Position the new trackball in the proper orientation over the existing standoffs. Make sure that the arrow on the trackball that points to the monitor is pointing up. Replace the 4 long screws and washers. Do not over tighten! Screw in until the lock washer is fully compressed. Reconnect the wiring connector and ground wire.

Note!

The field ground wire is critical to avoid electrical problems and assure optimal performance.

Button Replacement

All of the buttons on the control panel require a 1 1/8th inch hole, and are pre-drilled on the dedicated control panel. To remove a button, disconnect the wires from the button assembly by sliding the wires off of the micro switch posts. Next carefully twist the micro-switch assembly off of the button posts. Finally, unscrew the nut to remove the button from the control panel.

Place the new button assembly into the hole and position the smaller side of the micro-switch housing to face the rubber bumper, angled towards the middle. Tighten the supplied nut using a pushbutton wrench. Do not over tighten. Install the micro-switch by snapping it onto the pushbutton assembly by hand. Position the assembly so the micro switch posts face the rubber bumper, angling towards the middle. Reconnect the wires by sliding the wire assembly onto the contact posts of the appropriate micro switch. See the wiring diagrams in the back of this manual.

Control Panel Removal

To remove the control panel from its hinge, Disconnect the trackball cable, field-ground wire, and the control panel interconnect connector to the I/O board. Remove the screw that attaches the safety cable to the control panel. Remove the four 1/4" screws holding the panel to the hinge.

Control Panel Graphics Removal

The control panel artwork has been screened onto a solid sheet of polycarbonate, which is resistant to scratches and burns. Unfortunately long exposure to excessive situations may damage the surface over time. To remove and replace this piece, the pushbutton assemblies must first be removed. Next, remove the 4 T-20 security screws from the four corners of the panel. A T-20 Torx wrench has been included and ships inside the pocket on the back door. Separate the polycarbonate piece from the wood portion of the panel by starting at one corner and slowly peeling the two apart. The overlay has adhesive on the entire surface and will take some force to separate the pieces due to the adhesive. Once removed, the graphic overlay will not be able to be used again.

Control Panel Graphics Installation

To install a new polycarbonate Graphics overlay, make sure the wood control panel surface is clean, smooth, and free from dirt and debris. Remove the paper protecting the adhesive from the new artwork/cover panel. Carefully place it on the wood panel, aligning it properly. Press and smooth firmly to assure that it is secure. Install the 4 security screws in each corner of the panel. Be sure they are flush or below the surface to prevent injury. Replace the buttons in the correct orientation.

CABINET BEZEL

The molded bezel on the front of the Target Toss Pro: Bags cabinet is used to mount and secure a number of components. This bezel will need to be removed to gain access to the speakers, monitor and marquee.

Bezel Removal

First, remove the two security screws on either side of the cabinet that lock down the control panel. The bezel is held in place with 6 T-25 security screws, 3 on each side of the cabinet. Remove these screws. A T-25 Torx wrench has been provided in the pocket on the back door. Once all of the screws have been removed, lift the hinged control panel from the top, where the control panel meets the plastic bezel. Carefully loosen the bezel and pull it out slightly to allow access to the speaker connectors. Unplug both connectors. Carefully remove the bezel from the cabinet. Be careful not to pull on or excessively stress the plastic.

Bezel Installation

With the control panel open, place the bottom of the plastic bezel into position. Pivot it back far enough so the speaker connectors can be plugged back in, and do so. Push the bezel the rest of the way in, being careful not to pinch the speaker wires. The holes to secure the panel to the cabinet will align themselves if the bezel is properly placed into position. Install the 6 security screws, 3 on each side of the cabinet, to secure the bezel into place. Once the bezel is installed, close and secure the control panel with the 2 security screws.

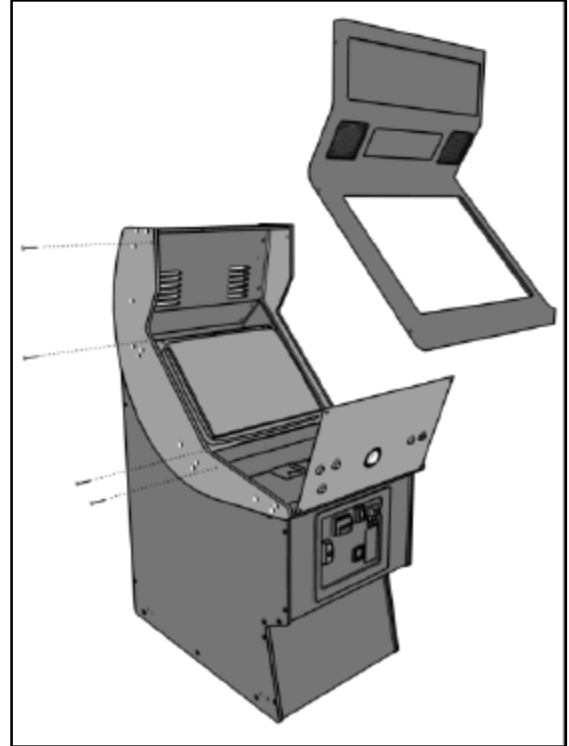

LIGHTED MARQUEE

Periodically a new version or update for Target Toss Pro: Bags will become available, requiring a new game marquee to be installed. Follow these directions for removing the existing marquee and replacing it with a new one.

Marquee Installation

Remove the cabinet bezel to access the marquee area. The marquee for dedicated cabinets should come with adhesive strips already attached. To install the new marquee, first make sure the area where the adhesive is to go is clean and smooth, and free of dirt and debris. Remove the strips of protective paper on the outer edges to expose the adhesive on the new marquee. Through the access opening in the back, line up the artwork appropriately and press on the outer edges to secure the marquee in place. Next, connect the power cable to the mating connector located at the access hole. Place the plate assembly back over the four Phillips head screws and slide it downward. Reinstall the two center screws and then tighten all six screws.

FLUORESCENT LIGHT FIXTURE

The Target Toss Pro: Bags cabinet uses a Happ Controls fixture. The ballast is a clamped core that works with a T8 Lamp - Happ Controls P/N 91-1228-00. The starter is FS2 Deluxe - Happ Controls P/N 91-2000-00. The Fluorescent bulb is an F15 T8 CW and is easily replaced once the back plate on the marquee header has been removed. As with all electrical devices, do not work on this component when the power is on.

SPEAKERS

The speakers are mounted in the bezel at head level, so players can best hear the audio. Sounds and speech are important aspects to the play experience and should be adjusted and maintained for optimal results. Make sure your speakers are in good working condition, are wired correctly, and are grounded properly to avoid buzz or hiss.

Speaker Access

In order to reach the speakers, the cabinet bezel must first be removed. Refer to the Bezel Removal section above. The speakers are located on the back of the bezel. Remove the 4 nuts with an 11/32" nut driver to remove the speakers from their mounting.

Note:

Both speakers must be identically wired to work properly. For optimal sounds, both speakers must be in phase with one another. Be sure the positive wire is connected to the positive terminal of each speaker and the negative speaker wire is connected to the negative terminal of each speaker. See the wiring diagrams in Appendix D.

MONITOR

Your Target Toss Pro: Bags cabinet comes equipped with a digital monitor set to SVGA resolution. Target Toss Pro: Bags dedicated cabinets support high-res. monitors, offering superb graphics and brilliant colors. Additionally, Target Toss Pro: Bags supports low-res, mid-res., VGA and SVGA monitors. Make sure the I/O Board and monitor are set properly for best game play results. The bank of dip switches marked SW201 on the I/O board control video settings. Your monitor may require additional adjustments to set it to the best resolution. Check your monitor's manual for more information.

Adjustments for color, brightness, contrast and image size are located under the control panel. Refer to the Control Panel section for information on how to access these controls. Monitors are delicate and can lose color or clarity if not treated properly. Never move a cabinet when the monitor is on. A game with a clear, bright monitor will attract more players and earn more money than a dim or poorly adjusted monitor.

I/O DIP SWITCH SETTINGS

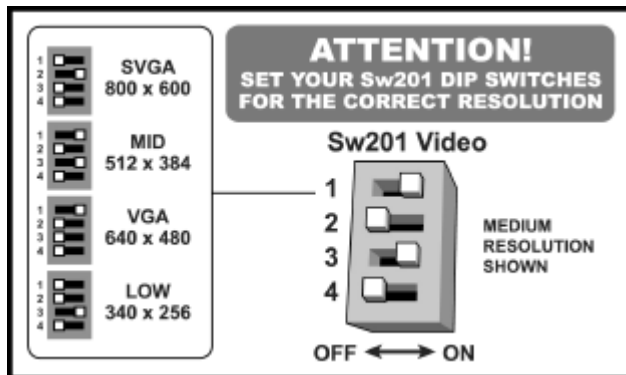

27" Monitor Removal

To remove the monitor, you first need to open the control panel and remove the cabinet bezel. Refer to those sections above for the proper removal procedures.

1. Once the monitor is exposed, disconnect the power cable and video connection at the back of the monitor.
2. The remote controller board should be re-routed from under the control panel to the back of the monitor and placed in the electronics area.
3. Be sure all wires that are not attached to the monitor are free and clear of the frame. Be sure that none of the cabinet wires are attached to the monitor by a connector or wire ties.
4. From the front, remove the 4 nuts from the studs of the monitor mounting brackets. Two of the nuts are located on the top and two are on the bottom. Do not remove the bolts holding the tube to the monitor frame.
5. It is best to have two people remove the monitor from the cabinet. Start with one person in the back to lift the monitor off the mounting studs. The second person should be positioned in front to guide the monitor out. The person in the back can then join the person in front to completely remove the monitor from the cabinet.

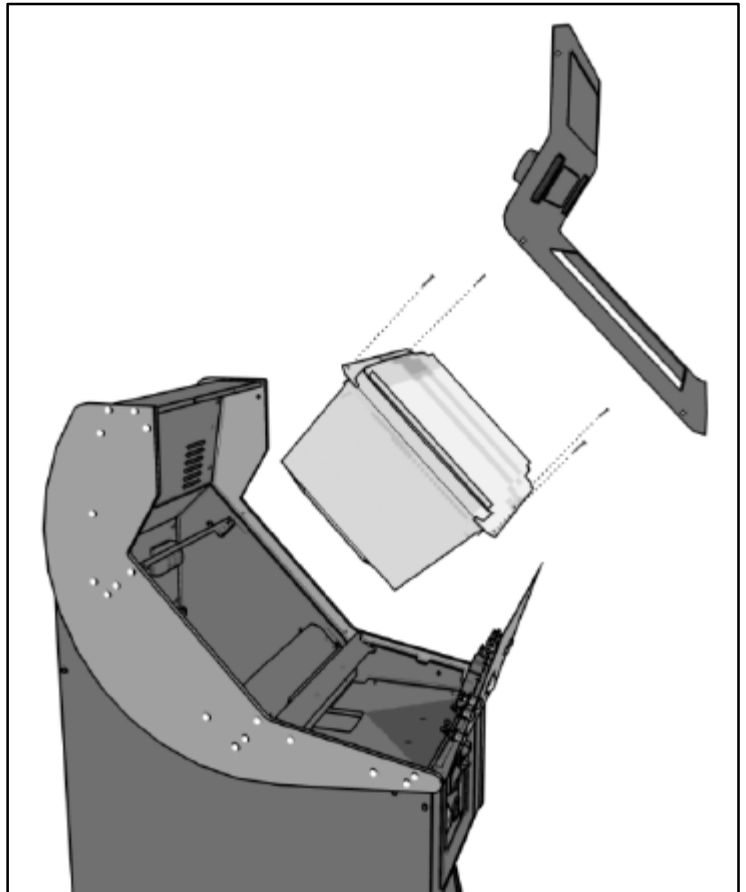

27" Monitor Installation

To replace the monitor into the cabinet, make sure all power is off, then open the control panel and remove the cabinet bezel. Refer to those sections above for the proper removal procedures.

1. Place the monitor into the monitor opening from the front of the cabinet. The electronics on the monitor should face into the cabinet. It is best to use two people to guide the monitor onto the mounting studs, located on the mounting brackets inside the cabinet.
2. Install the 4 nuts to secure the monitor to the mounting studs.
3. Route the controller board through the back of the control panel, and to the right side. Secure it with Velcro.
4. Attach the main monitor video cable from the LIVE system box to the video input of the monitor.
5. Attach the power cable to the power input cable of the monitor.
6. Dress cables with wire ties as needed to assure proper routing and reliability.
7. Turn the cabinet on to test the monitor. Adjustments are likely needed. Be sure the dip switches on the I/O board match the desired resolution. See the monitor's manual for more details.

See the Appendices in this manual for more help with System Setup Menus, Troubleshooting and more.



KIT INSTALLATION

KIT CONTENTS

- (1) Target Toss Pro: Bags Nighthawk System box
- (1) I/O Board Assembly
- (1) Cabinet Identification Device (CID)
- (1) 6' SVGA Cable
- (1) 6' Audio Cable
- (3) 6' USB Cables
- (1) A/C Power Cord
- (1) I/O Board Power Cable
- (1) 3" Trackball
- (1) Trackball Plate
- (1) TTP: Bags Marquee
- (1) TTP: Bags Control Panel Graphics
- (1) Set TTP: Bags Side Decals
- (1) Manual
- (1) Quick Install Guide
- (1) Parts bag containing buttons, cables and hardware

If any kit components are missing or damaged please contact Incredible Technologies Technical Support at 847-870-7027 x121. Replacement Parts can be found in Appendix C.

RECOMMENDED TOOLS

Have the following tools ready before you begin to install this kit:

- 1/4", 11/32" and 7/16" Sockets or Nut Drivers
- Phillips Head #2 Screw Driver
- 3/16", 7/32" and 9/32", or 5/16", 3/8", and 3/4" Drill Bits
- 1 1/8" and 3 1/2" Hole Saw or Drill Bit
- Small Flat Blade Screwdriver
- Jig/Sabre Saw
- Router
- Push Button Nut Socket or Large Adjustable Pliers
- X-acto® Knife or other Sharp Knife/Razor Blade
- Wire Cutters
- Scissors
- Tape Measure
- Putty Knife
- Decal Roller/Squeegee
- Liquid Window Cleaner & Cleaning Cloth
- Vacuum Cleaner
- Any tools needed to remove parts from your existing cabinet not listed above.

INSTALLATION PREPARATION

BEFORE YOU START...

Before you install the Target Toss Pro: Bags kit into your cabinet there are a few things you should check first:

1. Check to make sure your existing cabinet's monitor, speakers, AC power cord, lights, bill acceptor and coin mechs work. Replace or repair where necessary.
2. Check to make sure all the necessary parts are included in your kit. If any are missing/damaged please contact IT's Technical Support at 847-870-7027 x121.
3. Check to make sure cabinet is wired with standard earth grounded A.C. plug compatible with local building codes and/or safety requirements. If not, have a qualified electrician install one (not provided).
4. Have all the necessary tools available to install this kit. Refer to the recommended tools list to make sure you are prepared before you start.
5. Make sure any parts of the system (lights, monitor, etc.) are not plugged in. Working with any part of the system plugged in or powered on can be dangerous.
6. Keep in mind that it's been proven that the higher quality of work put into a kit installation results in a higher earning game. Make sure you have plenty of space, time, and focus to put into this kit installation.

PREPARING THE CABINET

CABINET SELECTION

You can choose either a new cabinet or a used cabinet for your Target Toss Pro: Bags game. Reusing a cabinet is a cost-effective way to maximize the return on your initial investment. In either case, all you need to provide is the cabinet with a monitor, JAMMA harness, coin and bill acceptors, working fluorescent/marquee lights, and speakers.

When selecting a cabinet, keep in mind that a larger control panel allows you to mount the trackball farther from the monitor. This prevents players' hands from hitting the monitor glass when rolling the trackball forward, and will earn better than a smaller control panel closer to the monitor. An older-model Golden Tee Golf dedicated cabinet is ideal for this purpose.

If using a Golden Tee Fore! cabinet for this installation, consider ordering a new Control Panel from Incredible Technologies. These control panels come pre-installed with controls and graphics, and can save you considerable time and money through easy installation.

PREPARING THE CABINET FOR INSTALLATION

Follow these steps to prepare your cabinet before installation:

1. Remove the following from the cabinet: Main Logic Board(s) (and hard drive if present), Control Panel, Monitor Viewing Glass, Marquee, and Power Supply. Now is a great time to clean both sides of the monitor viewing glass and monitor screen to ensure a clear view of the game.
2. Thoroughly clean out your cabinet. Remove all of the old buttons, joysticks, etc. **DO NOT** remove monitor and speaker wires or the wires that were previously hooked up to the control panel.
3. Remove the old graphics and adhesive from the cabinet including the control panel.
4. For a fresh look and best earnings, painting is highly recommended. Spray painting gives a better finish, but if an air brush or paint sprayer is unavailable a roller is second best. Remember to cover all exposed surfaces not to be painted. When not installing into an existing Golden Tee Fore! dedicated cabinet, the recommended color choice is black.
5. Make sure to have the sides of the cabinet and the control panel as smooth and flat as possible to allow for a higher quality finish when applying the control panel background, labels, and side decals.
6. The "new game look" should always apply to the inside of your game as well. A few wire ties and shrink tubing on your harness, some fastening hardware on your subassemblies, and a sweep with the vacuum cleaner will help ensure that glitches do not occur.

Check JAMMA Harness and Wiring

The Target Toss Pro: Bags Kit comes with a special I/O Board that uses your cabinet's existing JAMMA wiring harness. Make sure your existing wires and connectors are in good working order. Check the JAMMA wiring diagram in Appendix B.

Check Coin Mechs and Bill Acceptor

Make sure your coin mechs and bill acceptor are functioning properly, and your coin box and stacker are in good condition. You want to make sure your game will accept money when players are ready to play.

Check Coin Door Connections

Your cabinet should already be wired correctly through the JAMMA connector. Now is a good time to make sure your game can accept money. Check the JAMMA pinout chart in Appendix B for the correct wire colors and pins. Trace the wiring to their sources and make sure they are connected properly and securely. Be sure the wires are away from the coin door where they can be pinched or crimped.

Check Monitor

Target Toss Pro: Bags has been designed to operate with SVGA (800 x 600), VGA (640 x 480), medium resolution (512 x 384) and low resolution (384 x 256) monitor systems. The factory monitors in all Golden Tee Fore! cabinets are compatible with Target Toss Pro: Bags. However, to take advantage of the best and most current quality available, it is recommended to upgrade to an SVGA compatible monitor.

Operating Target Toss Pro: Bags at the highest possible resolution will give your game the best results (and revenue). Many standard cabinets contain a medium-res. or VGA monitor already. If you have a low-res monitor, it may be possible to switch it to a higher resolution. Check your monitor's manual for capabilities. If not, you should consider upgrading to a newer monitor.

Also check your monitor for a DB15 VGA connector. If your current monitor has a DB15 VGA connector, it is capable of VGA or SVGA resolutions. Check your monitor's manual on how to switch the monitor to VGA mode. Make sure the video dip switches on the I/O board match the resolution that the monitor is expecting. Plug the video cable from the Nighthawk System box directly into the monitor. Be sure to disconnect the old composite sync video cable from the monitor.

When operating with an SVGA or VGA monitor, Target Toss Pro: Bags uses the standard VGA sync timing and signals. When operating with medium resolution or low resolution monitors, which are common in Golden Tee Fore! dedicated cabinets, Target Toss Pro: Bags operates with composite negative serrated sync.

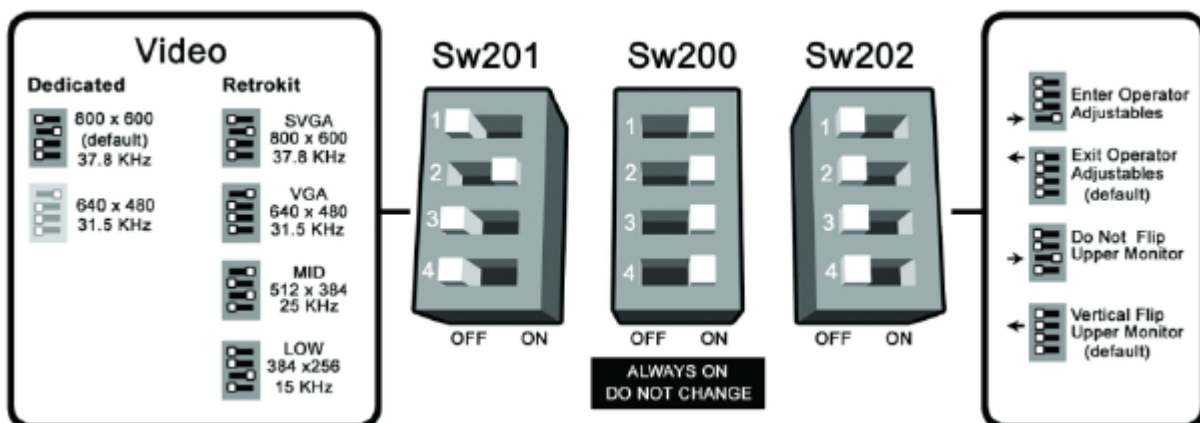

NOTE: In all cases a horizontal mount raster scan monitor is required.

CAUTION! Monitors are extremely dangerous and can result in severe injury. Make sure you follow and observe all safety precautions as outlined in your monitor's manual. **ALWAYS** disconnect the power to the cabinet before working on or around the monitor.

Remove Cabinet Graphics

Remove any decals from the cabinet. Make sure that the sides of the cabinet are as smooth and flat as possible to allow for a higher quality finish when applying the new side decals.

For a fresh look and best earnings painting is highly recommended. Spray painting gives a better finish, but if an air brush or paint sprayer is unavailable a roller is second best. Remember to cover all exposed surfaces not to be painted.

Remove Existing Card Reader (If applicable)

If you are using a Golden Tee Fore! cabinet, the existing card reader must be removed. Target Toss Pro: Bags does not require a card reader for operation. Install a metal plate to cover this opening.

Vacuum Cabinet Thoroughly

The "new game look" should always apply to the inside of your game as well. A few wire ties and shrink tubing on your harness, some fastening hardware on your subassemblies, and a thorough sweep with the vacuum cleaner will help ensure that glitches do not occur.

Dust and dirt can damage your hardware and cause problems with game play. Be sure that your cabinet is clean inside and out. It is highly recommended to vacuum your cabinet at least once a month, especially near the fans and vents, to avoid overheating and costly repairs.

ELECTRONICS INSTALLATION

INSTALL NIGHTHAWK SYSTEM BOX

The Nighthawk System box houses most of the game electronics and hardware into one box that can be easily installed. **Verify that the Nighthawk System box Power Switch is in the "ON" position.**

1. Locate the area on the floor where the system box will be placed. Make sure there is enough clearance to plug in cables.
 - The Nighthawk System box measures 19" W x 7" H x 11" D.
2. Relocate and secure any wires to make room for the system box.
3. Place the system box so it sits flat on the floor and does not pinch wires. Be sure there will be sufficient air flow to the system box. Overheating can damage your system.
4. Mount the system box with 6 - #6 x ¾" Hex Washer Head Sheet Metal Screws.

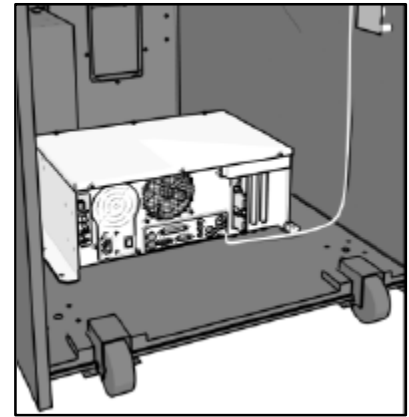

INSTALL CABINET IDENTIFICATION DEVICE (CID)

The Cabinet Identification Device or C.I.D. is an innovative and important component. This device permanently identifies your cabinet as Target Toss Pro: Bags. It should remain even if another component such as the I/O board or system box is replaced. The C.I.D. has a unique number to individualize the cabinet and is referred to as the Cabinet Identification Number.

1. Attach the C.I.D. to the inside side of the cabinet using the 2 - #6 X 1" Hex Washer Head Sheet Metal Screws. Mount so the port is facing up and the electronics face the wall.
2. Attach the USB cable from the Nighthawk System box.
 - Place the included Cabinet Identification Number on the back of the cabinet for future reference. **Refer to this number to track your equipment and whenever you are calling in for service.**
 - The Cabinet Identification Number is displayed in the operator menus in the lower right hand corner, and is labeled as Game ID. It is also displayed near the bottom of the initial boot-up screen.

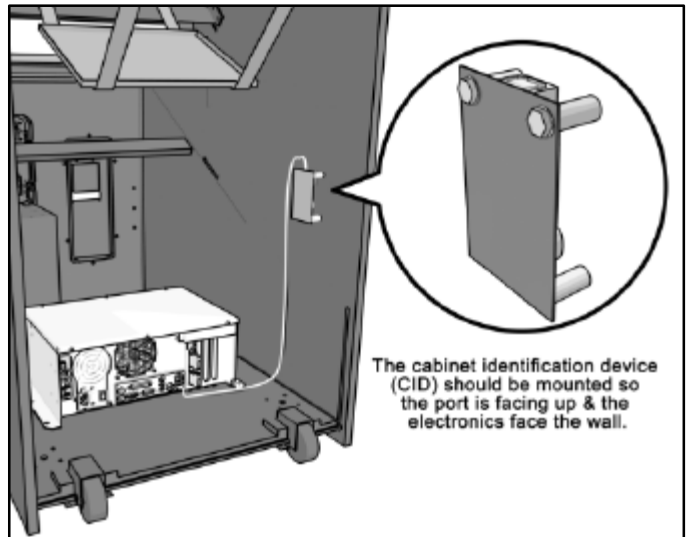

The cabinet identification device (CID) should be mounted so the port is facing up & the electronics face the wall.

INSTALL I/O BOARD

NOTE: Before installing any electronics make sure cabinet power switch is in the OFF position and the cabinet power is unplugged from the wall.

Target Toss Pro: Bags comes with a specially designed I/O board that works with your cabinet's already installed JAMMA harness. The I/O board is used as a connection interface between the JAMMA and the Nighthawk System box.

Mount the I/O board inside the cabinet using 4 of the 6 x 3/4" Hex Washer Head Sheet Metal Screws, 1 in each corner. The existing JAMMA harness edge connector will attach to this board. Do not attach cables at this time.

NOTE: Route all cables AWAY from the I/O Board. Laying cables on top of or below the I/O Board will result in unwanted noise or static during the game.

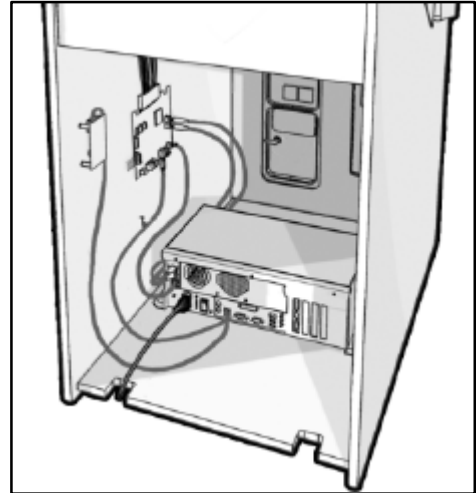

CONTROL PANEL INSTALLATION

INSTALL OPTIONAL CONTROL PANEL FOR EXISTING I.T. CABINETS

If you are installing your kit into an existing Golden Tee Fore! cabinet manufactured by IT, you can purchase a new, fully outfitted control panel. This will not only make your installation easier, it will make your game look and play better too. Use this section to install this control panel. For all other cabinet types, refer to the next section.

Attach the new control panel to the existing hinge on the control panel drawer. Drive the 4 Phillips screws into the holes in the bottom of the control panel. The control panel comes equipped with trackball and buttons in place. Snap the switches onto the buttons. Refer to the JAMMA wiring diagram to match up the correct wire to the correct button. The following buttons need to be connected: Start/Options, Shot Type, High Toss, and Low Toss. Connect to the normally open post. Be sure common ground is connected to each common post. Finally, connect the Trackball to the trackball connector J208 on the I/O board.

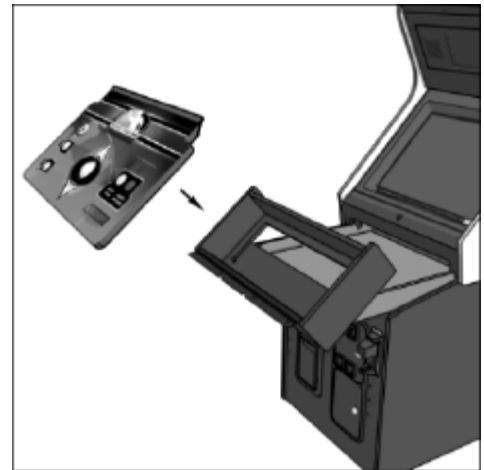

TRACKBALL AND BUTTON PREPARATION (FOR MOST KITS)

Mounting the trackball and buttons correctly and securely is very important for the profitability and safety of your new game. This kit is designed for use in cabinets with $\frac{3}{4}$ " thick wood control panels where proper routing of the control panel is used to create a safe playing experience. If you do not have a $\frac{3}{4}$ " thick wood control panel, please replace your control panel or choose a cabinet with a $\frac{3}{4}$ " thick wood control panel installed. Keep in mind that if your current control panel has many old holes in it from previous buttons, joysticks, etc. that it may be easier to start with a new solid control panel. This will give your game a better look and feel and help it to earn better.

NOTE: If the cabinet already has a trackball plate installed, discard and replace with the new trackball plate. The metal trackball mounting plate and trackball mounting procedure have been designed to remove all bolts from the playing surface. Routing the wood control panel is required so the metal mounting plate is flush with the panel surface. An uneven playing surface or exposed edges will affect game play and could impact your earnings.

TIP: Trackball and button templates can be found in Appendix G of this manual. They include:

- Trackball Template to install the trackball plate and make the appropriate routing.
- Trackball Orientation Diagram to orient your trackball correctly when installing.
- Button Set Templates to position and install control panel buttons.

Trackball Preparation

Install the metal trackball plate by following these steps:

1. Cut out the template from Appendix G with a pair of scissors along the noted line. Tape this template to the top of the control panel as far away from the monitor as possible, making sure that the trackball will clear the cabinet beneath it. **NOTE:** Installing the trackball as far away from the monitor as possible will prevent players' hands from hitting the monitor glass when rolling the trackball forward.
2. Using a sharp object, mark the eight points shown on the template on the control panel. Using a pencil, trace the outside of the template. Remove the template.
3. Drill Holes 1-4 with a $\frac{9}{32}$ " or $\frac{5}{16}$ " drill bit.
4. Drill Holes 5-8 with a $\frac{3}{4}$ " drill bit.
5. Route the crosshatched region to a depth of about .075" (about the thickness of a nickel).
6. Using a sabre saw cut out the center portion by cutting between holes 5-8.
7. Once you have cleaned up the routed area, install the trackball plate into the control panel using the $\frac{1}{4}$ " Flat Washers and $\frac{1}{4}$ -20 Nylon Hex Nuts. Be sure the mounting plate is flush with the top of the control panel.

NOTE: At this time you are only installing the trackball plate, do not install the trackball yet.

Button Preparation

The following are the steps you should take to prepare your control panel for the installation of the button assemblies:

1. Cut out the template(s) (see Appendix G).
2. Using a tape measure, measure the specified distances from the center of the trackball hole in the trackball plate and make a mark the reference points indicated on the left and right button set templates (see Appendix G).
3. Lay each template over the appropriate reference marking point. Mark the centers of the remaining holes using a sharp object.
4. Drill a 1 $\frac{1}{8}$ " hole at each marked point.

NOTE: Do NOT install the trackball or buttons until the control panel graphics have been applied.

Once the installation is complete, be sure to use the System Controls test in the game's System Setup menus to ensure proper functionality of all the player controls.

CONTROL PANEL OVERLAY INSTALLATION

Target Toss Pro: Bags comes with an oversized control panel overlay that will accommodate a variety of existing game cabinets, but works best on Golden Tee Fore!, NFL® Blitz™ and EA Sports™ PGA Tour® Golf cabinets. Follow these instructions to correctly install the control panel overlay on one of these cabinets:

1. Make sure that the newly drilled control panel has a smooth, clean surface. Sand where necessary to make sure the graphics are installed on an even surface.
2. Clean the control panel to make sure it is free from dust, grease, metal filings, etc. Make sure that all residues (adhesive, overlay material, etc.) from the previous control panel graphics are removed. This will ensure a clean, easy, and beautiful application of the control panel graphics.
3. **It is very important that the trackball and control panel graphics be mounted perfectly straight.** Find the center of your trackball template and lightly draw vertical and horizontal guidelines on the control panel, marking out your centering lines.
4. Remove a small section of the protective backing from the overlay. Carefully center the overlay over the control panel by lining up the die-cut hole with the trackball template. **Be sure the graphic is positioned perfectly straight.** Line up your pencil guidelines with the lines incorporated into the art. Once in position, gently press down on the section with exposed adhesive, affixing the overlay into place. Once affixed, the overlay cannot be removed.
5. While holding down the overlay over the attached area, very carefully turn over one side and remove the exposed backing. Gently lay down the exposed overlay from the center outward, smoothing with your hands or a roller as you go. **Be sure the overlay remains straight and square.** Repeat the process with the other side of the overlay, so the entire surface is affixed to the control panel. Make sure all bubbles have been pressed out for a clean, flat surface.
TIP: Liquid window cleaner can be sprayed onto the control panel before placing the overlay onto the control panel. The window cleaner will allow the overlay to be positioned with less risk of damage to the overlay or adhesive. Once in position, use a decal roller or squeegee to force any excess cleaner out. Be sure to add additional time for the liquid to evaporate.
6. Using a razor knife (or other sharp instrument) carefully cut around the edges of your control panel, trimming any excess material.
7. Find the center of each hole you've drilled out for the buttons and use the knife to poke a hole into the overlay. Make a vertical and horizontal line (like a plus sign) from the center of the hole to the edges. You should be able to place your button in later with no edges showing.

CAUTION: If you choose to install a Plexiglas® cover over your control panel (not recommended), to ensure the safety of your players and the quality of your game make sure that all surfaces, edges and bolts that a player may come in contact with are smooth, safe and secure.

FINISHING THE CONTROL PANEL

1. Reattach the control panel to your cabinet adjusting any hinges or chains where necessary. Make sure not to pinch or crimp any wires while re-attaching the control panel.
2. Install the trackball into the trackball plate. The trackball must be oriented correctly in order to function properly. Refer to the diagram located in Appendix G for correct orientation. You will need the following parts in order to install the trackball correctly to the plate: 4 - 10/32 x 2½" Phillips Head Machine Screws, 4 - #10 Flat Washers and 4 - #10 Split Lock Washers **NOTE:** Do not over-tighten the trackball. It will warp and cause the trackball to not operate correctly.

IMPORTANT! Be sure to install your trackball securely, and maintain it regularly. Loose, worn, or incorrectly mounted trackballs can result in decreased earnings and possible injury to players.

3. Secure the trackball ground wire to the trackball plate at the 8-32 stud on one end with an 8-32 KEPS nut and the other end to the cabinet ground stud (usually located near the AC power cord inlet) using an 8-32 KEPS nut.
4. Install the buttons in the holes located on your control panel. Make sure you use the red button assembly for the Start button.
5. Attach the micro switches to your newly installed buttons and connect the wires up to the correct pins on the JAMMA harness.



NOTE: The post on the switch labeled COM should connect to the ground wire and the post labeled NO should connect to the signal wire. See the JAMMA pin out chart in Appendix B.

IMPORTANT! Trackball and trackball plate **MUST BE GROUNDED** to Earth Ground to prevent damage to the trackball or game electronics.

COMPLETE SYSTEM BOX CONNECTIONS

Follow these procedures to correctly connect the various electronic components. Be sure the cables are connected securely and in working order. Use cable clamps, with appropriate tension, where necessary to ensure all cables stay in place during operation. Dress all cables with additional clamps and wire tie wraps where needed. Avoid loose wires or disconnected cables, as they can cause an unneeded service call.

ATTACH I/O POWER, AUDIO, AND USB CABLES

- ◆ **I/O board power cable.** Connect from the I/O board to one of the two 4-pin power output connectors on the system box.
- ◆ **Audio cables.** Connect to the audio output jacks of the system box. Match the appropriate colors.
- ◆ **USB cable #1.** Connect from the I/O board to any USB port on the system box.
- ◆ **USB cable #2** for future updates. Attach to any USB port on the system box. Route the other end to the control panel for easy access when updating.
- ◆ **USB cable #3** for Cabinet Identification Device (CID). Refer to the CID Installation Section for proper orientation and placement of the CID.

ATTACH MAIN VIDEO CABLE

If your cabinet has a VGA or SVGA monitor, connect the video cable from the system box directly to the VGA or SVGA monitor input.

If your cabinet has Medium or Low Resolution monitor, connect the video cable from the system box to the I/O board.

Be sure to adjust your Dip Switch settings to match your monitor's resolution. Refer to Appendix D.

ATTACH POWER CABLE

Use the AC power cord that is currently in your cabinet. The cord plugs into the System box. Have a qualified electrician do the wiring. Verify A.C. main voltage selector switch is in the proper position. In North America the setting is 115 volts AC. In some countries this should be set at 230 VAC.

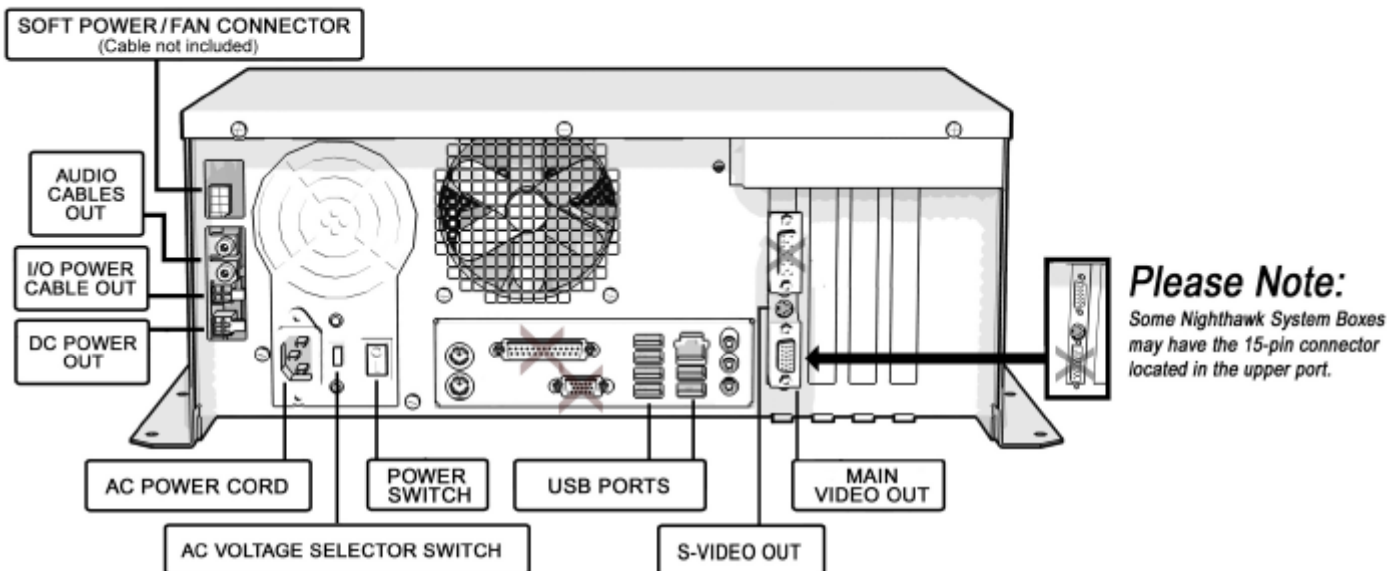

COMPLETE I/O BOARD CONNECTIONS

CONNECT JAMMA HARNESS

Connect the JAMMA Connector to the I/O Board. Be sure it fits tightly and is oriented correctly.

CONNECT THE CONTROL PANEL SWITCHES AND CABLE

Snap the switches onto the buttons. Connect the Control Panel wiring harness using the JAMMA wiring chart found in Appendix B.

CONNECT COIN DOOR LAMPS

Connect the coin door lamp cable to the pigtail off the I/O Power cable. If your cabinet originally had a Golden Tee Fore! green PCB, then use the 9-pin connector. If your cabinet had a Golden Tee Fore! red PCB, then use the 4 pin connector. Find the mating connector leading to the coin door to make your connection.

CONNECT THE TRACKBALL

Locate the Trackball Cable and connect it to the connector labeled Trackball on the I/O board. The other end will connect to the trackball. Connect the green earth ground wire to the trackball plate.

CONNECT AUDIO CABLES

Locate the Audio Cables already connected to the system box, and connect them to the I/O board audio inputs. Inputs are color coded, so be sure to connect red to red, etc.

CONNECT THE USB CABLE

Locate the 6 ft. USB Cable from the system box and connect it to the USB port on the I/O board.

CONNECT MEDIUM OR LOW RESOLUTION MONITOR

If your cabinet has a Medium or Low Resolution monitor, you need to connect the video to the I/O board. Connect the SVGA Video cable from system box to the J501 connector on the I/O Board. Connect the Red, Green, Blue video outputs, the composite sync, and video ground from the JAMMA connector to the appropriate monitor inputs. To find the correct JAMMA pin outs refer to the diagram in Appendix B. Be sure to set the Video Dip Switches on the I/O Board to match your resolution. Refer to the diagram in Appendix D.

CONNECT VGA OR SVGA MONITOR

VGA or SVGA monitors are connected directly to the system box video output. Do not connect a video cable to the I/O Board if you are using these resolutions.

CONNECT I/O POWER CABLE

Connect the I/O Power cable to the power input connector. Use the end with the pigtail. The other end connects to the system box.

CHECK ALL CONNECTIONS

Go over your entire cabinet again and double-check all of the connections. Make sure that all connectors are tight and secure and in their proper place. Look for frayed, broken or exposed wiring and repair as needed. Bundle and wire-tie your wiring and secure it to the inside of the cabinet. A thorough and neat job now will save you a lot of time and trouble in the future.

CABINET GRAPHICS INSTALLATION

Included with your Target Toss Pro: Bags kit is a set of decals to place on the side of your cabinet and a brand new marquee. This will help identify your new game as Target Toss Pro: Bags. By placing and installing these correctly it can help give players instant recognition, even from a distance.

SIDE DECAL INSTALLATION

The following are the instructions on placing your side decals correctly on to the cabinet:

1. Locate the place where the side decals will be viewed best on your cabinet. Refer to the diagram included on the decal sheet and to the right of these instructions for optimal placement.

NOTE: Make sure to have the sides of the cabinet as smooth and flat as possible, removing all previous residue from prior decals, to allow for a higher quality finish.

TIP: Liquid window cleaner can be sprayed onto the sides of the cabinet before placing the decals. The window cleaner will allow the decal to be removed and re-installed without damaging the decal or adhesive. The decal roller or squeegee forces the cleaner out, leaving just the adhesive.

2. Remove the first of the new cabinet side decals from the backing.
3. Center the first decal on the location selected for your cabinet.
4. Using your hands (or a decal roller/squeegee), press down firmly starting from the center and smooth the side decal outward. Make sure all bubbles have been pressed out for a clean, flat surface.
5. Repeat for each of the remaining side decals.

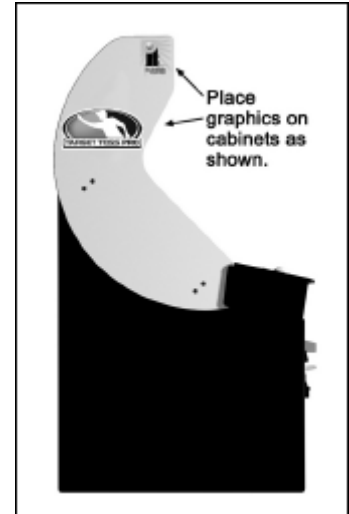

MARQUEE INSTALLATION

The following are the instructions for placing the new marquee in your cabinet:

1. Using the old marquee glass as a template, center the glass on top of your new marquee. Make sure that all the printed images are visible.
2. Using an X-acto® knife or other sharp blade, score the new marquee deeply by following the edges of the old glass as a guide.

CAUTION: Do not cut on table or counter top. Use a cutting board or a disposable surface.

3. Carefully break off any excess material you have cut off.
4. Be sure the light behind the marquee works.
5. Clean the glass on both sides to give players a clear view of the new marquee.
6. Install the marquee graphics and glass securely.



FINAL CONNECTIONS

COIN DOORS, TEST SWITCH, AND VOLUME CONTROLS

Wire the coin doors as per the JAMMA Harness Connection table in Appendix B. Connect the door lamps to the appropriate (+12Vdc or +5Vdc) supply. Some games have separate power supply outputs for the lamps. Install a test switch somewhere convenient inside the coin door area. This switch allows you to enter adjustables, run diagnostics, and see or clear audits. Make it readily accessible through the coin door. Wire it to the Test wire on the JAMMA Harness. Target Toss Pro: Bags has the ability to adjust volume at any time during a game. Install two push button switches (not included) inside the coin door for easy access. Connect the switches to the JAMMA harness. Refer to the JAMMA Harness Connection table in Appendix B.

INITIAL POWER-UP

There are several steps you should take when powering up your Target Toss Pro: Bags for the first time. This is a quick checklist for you to follow when doing your first initial power-up:

- ❑ Plug in the game and turn it ON; be sure the game powers up correctly into the attract mode.
- ❑ Adjust volume levels to desired settings.
- ❑ Adjust monitor settings for best picture.
NOTE: Sound and Video Tests are available through the System Tests Menu. They are beneficial when making any adjustments. Proper monitor and sound adjustment is very important.
- ❑ Try all money slots. Drop quarters or tokens through to check the coin mechs and insert a bill into the bill acceptor. Make sure the game is adding credits.
NOTE: Target Toss Pro: Bags supports most bill acceptors. Installing a bill acceptor is highly recommended and will increase your earnings. Refer to your bill acceptor's manual for installation specifications. The bill acceptor can be wired to coin door 3 on the JAMMA.
- ❑ Test all of the player input controls. You can use the PLAYER CONTROL TESTS in the SYSTEM SETUP MENU.
- ❑ Upon initial power-up the game is set to factory default settings. These settings affect game elements such as number of credits per coin, volume settings, etc. The SYSTEM SETUP MENUS section will describe how to alter these settings for your location.

**Congratulations! You have finished installing
Target Toss Pro: Bags!**

SYSTEM SETUP MENUS

Navigating The Menu System

The System Setup menus cover a variety of important areas including collections, tests, game adjustments, and optional settings. You should familiarize yourself with these menus, as they are designed to optimize your game for your location and your business. Pay particular attention to the Collection menus, as they will detail how much money to give to your location, and how to maximize your split. There are menus that allow you to adjust various split percentages for a variety of different charges. These screens can help you maximize your investment and involve your location in the costs associated with your equipment.

Entering System Setup Mode

There are two ways to enter System Setup. Open the coin door and press the Test button to access the game's System Setup software menu system. Or, from the I/O board, move the dip switch SW202 position 4 to the ON position. This switch needs to be moved back to OFF to exit the System Setup menus.

Selecting a Menu

A menu option can be selected at any time by rolling the trackball up or down or by pressing the Up or Down buttons.

Choosing a Menu/Option

A menu option can be chosen at any time by pressing the Start Button.

Changing a Value

A value can be changed at any time by rolling the trackball left or right.

NOTE: Some features may not be allowed in certain state or local jurisdictions. Be sure to check your local laws before activating or allowing any features that may be questionable in your area.

MAIN MENU

The Main Menu displays four main areas that make up System Setup mode. Please familiarize yourself with these areas, as they will help you maximize your earnings potential.

Collections & Earnings

This section displays your machine's monetary activity, and details the various areas for income and expenses. This section should be reviewed during every collection, to make sure you manage your split correctly.

General Settings

This area allows you to adjust operator adjustables, perform system tests, and reset your game back to factory settings.

Troubleshooting Shortcuts

This section presents a variety of tests and menus that will help you troubleshoot any problems you may be having with your game. The available sections are also accessible through the other main sections.

Settings & Audits

This area allows you to adjust settings specific to Target Toss Pro: Bags including the player cost schedule, game features, and game audits.

Back

This will exit the System Setup menus and take you back into the game's attract mode.



COLLECTIONS & EARNINGS MENU

This menu allows you to perform a collection or view various earnings and fees.

Do Collection

This section is used when making a collection. The various screens will detail the cost breakdowns and show you how much of the cash box is to be paid to the location. Please take some time to familiarize yourself with this section. Using it wisely can save you money.

Clear Unused Cash

Sometimes when you go to make your collection, there is money in the game that has not been played yet. Use this setting to clear the unused cash from the game, so your future collections will reconcile with game play.

Add Free Cash

Use this setting if you wish to add money to the game for free plays that do not advance the hard meter.

Back

This will take you back to the **Main Menu**.



DO COLLECTION

This screen is the main collection screen. There is a lot of helpful information displayed that will help you with your collection. It is highly recommended that you view this screen with every collection, and reset it when your collection is complete.

This screen displays the following helpful information:

Collection Date Range

The displayed dates are from your last collection until today.

Days In Operation

The number of days the machine was active and available for play since the last collection.

Reset

Highlight this to reset the number of days in operation field to '0'.

Total Income

The total income your machine made for this time period.

More Details

More Details displays a breakdown of the types of money collected.

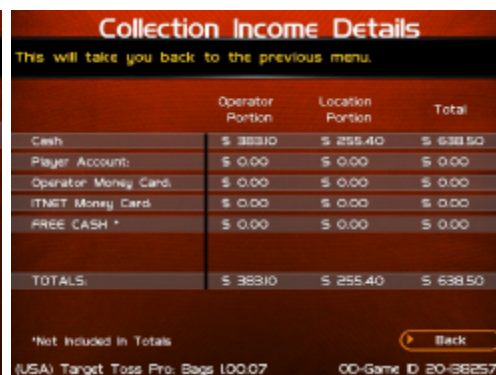
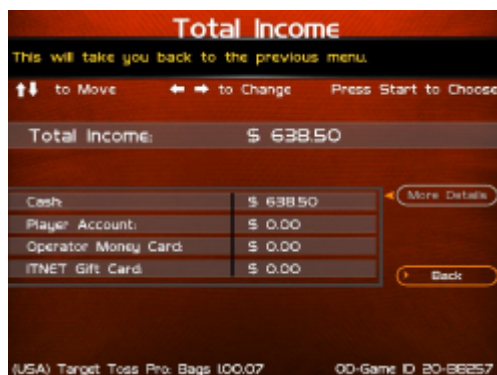
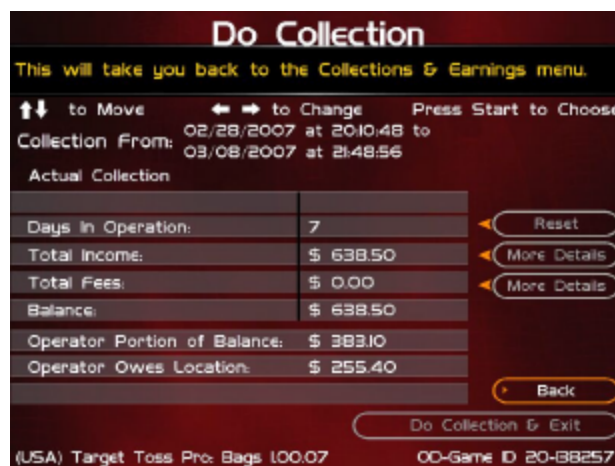

Total Fees

The total of the various fees that need to be set aside before making your split.

More Details

More Details displays a breakdown of the various fees (if applicable).

Balance

The total income minus the total fees.

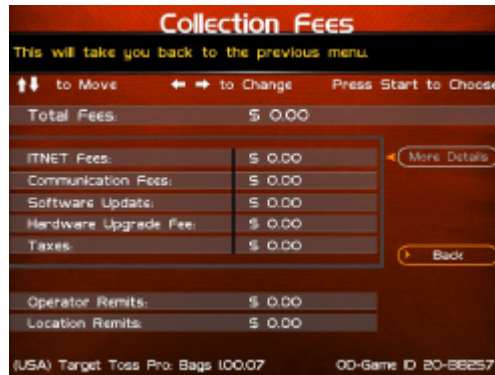

	Operator Portion	Location Portion	Total
ITNET Fees:	\$ 0.00	\$ 0.00	\$ 0.00
Communications Fee:	\$ 0.00	\$ 0.00	\$ 0.00
Software Update Fee:	\$ 0.00	\$ 0.00	\$ 0.00
Hardware Upgrade Fee:	\$ 0.00	\$ 0.00	\$ 0.00
Taxes:	\$ 0.00	\$ 0.00	\$ 0.00
TOTALS:	\$ 0.00	\$ 0.00	\$ 0.00
Operator Remits:	\$ 0.00	To Incredible Technologies	
Operator Remits:	\$ 0.00	To Tax Authorities	
Location Remits:	\$ 0.00	To Tax Authorities	

Operator Portion of Balance

The amount of the collection that the operator keeps.

Operator Owes Location

The amount of the collection that you pay your location.

Back

If you do NOT wish to perform a collection and reset the audits, highlight Back to exit this screen and return to the **Collections & Earnings** menu.

Do Collection and Exit

If you wish to perform a collection and reset the audits (recommended), highlight Do Collection and Exit and press Start. This will set all the fields in the Do Collection screen to zero. Be sure to empty your cash box at the same time, so these screens will match the money at your next collection.



GENERAL SETTINGS

The General Settings menu houses various adjustable settings relating to the cabinet, and is divided into three sections.

Operator Adjustables

This area allows you to adjust options like volume, attract mode sounds, and money slot settings.

System Tests

This area allows you to perform diagnostics including video adjustments, input tests, and sound tests.

Advertisements

This area allows you to manage various graphic and text advertisements on your machine. This section is currently unavailable but is planned for a future update.

Back

This will take you back to the **Main Menu**.



OPERATOR ADJUSTABLES

This menu contains adjustable settings that pertain to you and your business. Please familiarize yourself with this section, as it can help you maximize the game's earning potential.

General Adjustments

This area allows you to adjust options like coin message, game mode and monitor mode.

Money Slot Adjustments

This area allows you to adjust the settings of your various money slots on your cabinet.

Sound Adjustments

This area allows you to adjust the various sound settings including attract mode sounds, game volume, and stereo setup.

Collection Settings

This important area allows you to adjust various fees and splits for your collections.

Reset To Factory Settings

This option allows you to reset all the settings found in the Operator Adjustables section to factory defaults.

Exit

This will take you back to the **General Settings** menu.



GENERAL ADJUSTMENTS

Coin Message

Is set to "Insert \$" by default and requires the player to insert money. No other modes are available.

Game Mode

This lets you toggle between money/free play. **The default is set to Money Play.**

2nd Monitor Mode

You can connect a second monitor to the extra video connector on the system box, which is great for promotions or special events. Select S-Video if your second monitor is a television screen, or SVGA if your second monitor is an RGB monitor. The default setting is S-Video.



Note: The S-Video setting will only work if your game screen is running in high-res mode. If your game monitor is mid-res or low-res, the S-Video signal will not display an image.

Reset Values

This resets all values to their default value located on this page.

Back

This will take you back to the **Operator Adjustables** menu.

MONEY SLOT ADJUSTMENTS

Money Slot 1 (all machines)

This adjusts how much one pulse equals for Money Slot 1.

Money Slot 2 (kits only)

This adjusts how much one pulse equals for Money Slot 2.

Money Slot 3

This adjusts how much one pulse equals for Money Slot 3.

Reset Values

This resets all values to their default value located on this page.

No

This will not perform the reset and take you back to the previous menu.

Yes

This will perform the reset and take you back to the previous menu.

Back

This will take you back to the Operator Adjustables menu.



SOUND ADJUSTMENTS

In Game Volume

This option lets you adjust the In Game volume from OFF to 100%. **The default is set to 30%.**

Attract Volume

This option lets you adjust the Attract Volume from OFF to 100%. **The default is set to 20%.**

Attract Mode Sounds

This adjusts how often sounds are played in the attract mode: Never, Rarely (every 20th time), Sometimes (every 10th time), Often (every 5th time), and Always. **The default is set to On - Sometimes.**

Stereo/Mono

This option is where you select stereo or mono setup. **The default is set to Stereo.**

Reset Values

This resets all values to their default value located on this page.

Back

This will take you back to the **Operator Adjustables** menu.



COLLECTION SETTINGS

Target Toss Pro: Bags allows you to adjust costs and percentages for the various income types that are received. Use this menu to determine how much you want your location to help you pay for these charges and services.

Set Hardware Update Fee

This menu allows you to adjust the Hardware Update Fee. This fee is included for your convenience, as a method to have the location pay for part of your equipment. The default value is \$0.00 per week.

Operator/Location Income Splits

Use this menu to fine-tune your splits for any generated income. Since there may be times when you have to pay the location before you actually have the cash in hand, you may want to adjust the split in your favor to cover the waiting period. The default settings are displayed on the accompanying screen.

The adjustable settings refer to income generated from:

Cash

Player Account (N/A)

ITNet Money Card (N/A)

Operator Money Card (N/A)

Operator/Location Fee Splits

Use this menu to determine how you wish to split the various fees with your location.

ITNet Fees (N/A)

Communication Fees (N/A)

Software Update Fees (N/A)

Hardware Update Fees

Note! Hardware and Software Update Fees are included for your convenience, if you wish to have the location help cover some of your costs.



Tax Settings

Many states require special taxes or license fees that affect your bottom line. Use this menu to separate these costs from your collection before making your normal split.

Set Tax Rate

This menu allows you to adjust your current tax rate percentage.

Set Tax Type

This menu helps you determine what part of the collection is taxed, and who pays for these taxes.

Set Tax Split

This menu allows you to split the tax fees with the location.

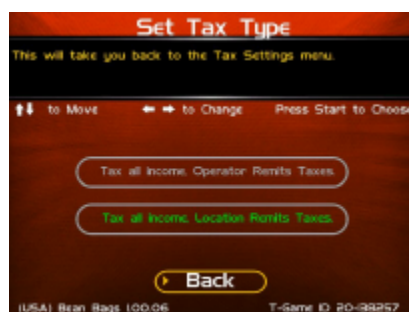
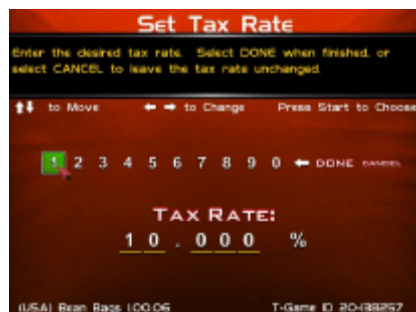

Back

This will take you back to the **Collection Settings** menu.

Reset to Defaults

This menu will set all of the collection settings to their factory default values. A verification screen will display to make sure you agree to the change.

RESET TO FACTORY SETTINGS

This menu will reset ALL settings in the Operator Adjustments section to their default values. A verification screen will display to make sure you agree to the change.

Exit

This will take you back to the **General Settings** menu.



SYSTEM TESTS

This area allows you to perform diagnostics including video adjustments, input tests, and sound tests.

Video Tests

This area has tests that will help you to adjust your game's color, contrast, and screen size.

Sound Tests

This area has tests that will help you adjust your game's audio setup by playing a stored sound, a streaming sound, and testing the speaker(s).

Player Control Tests

This option allows you to test all inputs including trackball, buttons, money slots, etc.

Mechanical Meter Test

This test makes the hard meter adjust by one to make sure it is functioning properly.

Hardware Tests

This area includes a series of diagnostic screens and tests to help you make sure your game is functioning correctly.

Exit

This will take you back to the **General Settings** menu.



VIDEO TESTS

The Video Tests section has a variety of tests that will help you adjust your monitor.

Color Adjustments

This area will take you to a series of tests to adjust your monitor's RGB settings to have each color display properly.

Contrast Adjustments

This area will take you to a series of tests to adjust your monitor's brightness/contrast so the game displays properly.

Screen Size Adjustment

Use this screen to align your monitor so that all the circles appear as circles and the boundary line appears on the edge of each side of the screen.

Back

This will take you back to the **System Tests** menu.



COLOR ADJUSTMENTS

Color Grid Adjustment

Adjust your monitor to have each colored box display properly.

Red Screen

Adjust your monitor to have red display properly.

Green Screen

Adjust your monitor to have green display properly.

Blue Screen

Adjust your monitor to have blue display properly.

Back

This will take you back to the **Video Tests** menu.



CONTRAST ADJUSTMENTS

White Screen

Adjust your monitor to have white display properly.

50% White Screen

Adjust your monitor to have 50% white display properly.

25% White Screen

Adjust your monitor to have 25% white display properly.

Black Screen

Adjust your monitor to have black display properly.

Contrast Screen

This option is a test you can use to adjust your monitor's contrast and brightness settings to have the boxes displayed properly.



Note: May not work on older or often used monitors. If you have a monitor that's old or has been used often you may not be able to adjust the contrast and/or brightness levels accordingly. In this case adjust the monitor for best performance while getting close to the recommended settings.

Exit

This will take you back to the **Video Tests** menu.

SCREEN SIZE ADJUSTMENT

Use this screen to adjust the size and aspect ratio of your picture. Press the Start button to exit.

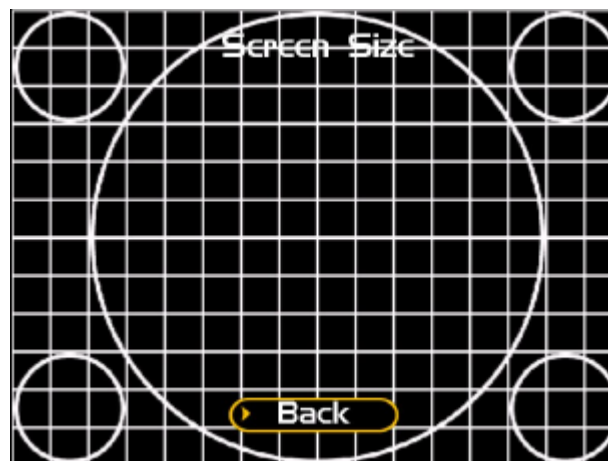

SOUND TESTS

Stored Sound

This will play a stored sound so you can make sure your audio setup is functioning properly.

Streaming Sound

This will play a streaming sound so you can make sure your audio setup is functioning properly.

Speaker Test

This test will say MONO if you have your game set to Mono or LEFT and RIGHT if you have it set to stereo so you can make sure your audio setup is functioning properly.

Back

This will take you back to the **System Tests** menu.



PLAYER CONTROL TESTS

Use this screen to test all of the inputs, including the trackball, buttons, and money slots. When an input is active the appropriate graphic image will light. Press the Up, Down and Start buttons simultaneously to exit this test screen.

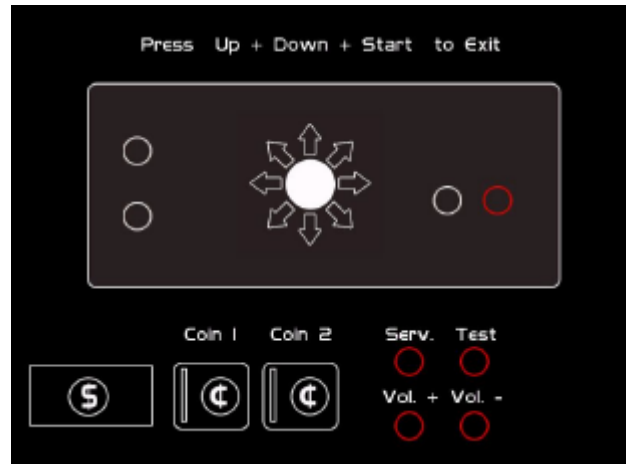

MECHANICAL METER TEST

Click Meter

This test makes the hard meter adjust by one to make sure it is functioning properly.

Back

This will take you back to the **System Tests** menu.



HARDWARE TESTS

This area includes a series of diagnostic screens and tests to help you make sure your game is functioning correctly.

Hardware/Software

This area has options to view your system and USB info.

Check Hard Drive

This test checks the integrity of your hard drive's data.

Note: This test can take several minutes.

Check Cooling

This test helps you make sure your game is functioning at the proper temperature and all fans are working.

Check Card Reader (N/A)

Back

This will take you back to the **System Tests** menu.



HARDWARE/SOFTWARE

System Info

This is a list of your game's current basic system information, including Hard Drive, CPU and Video Card.

USB Info

This is a list of your game's current USB devices.

Version Info

This is a list of your game's software version.

Back

This will take you back to the **Hardware Tests** menu.

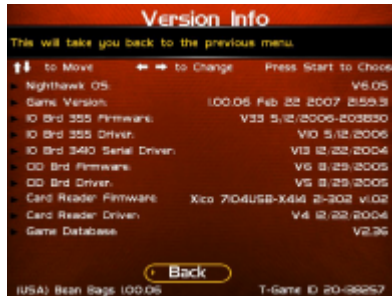
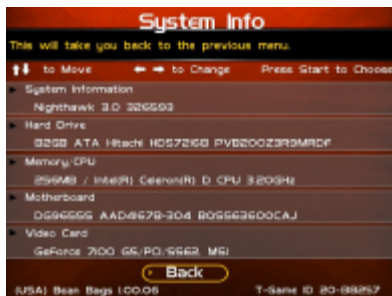
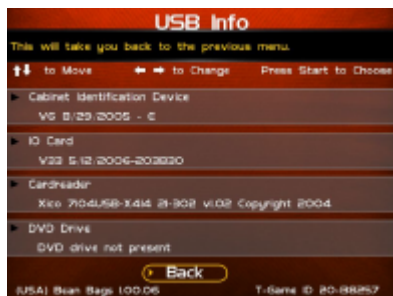

CHECK HARD DRIVE

Check File Data

This test checks the integrity of your hard drive's data.

Select **Begin Test** to initiate the process.

Note: This test can take up to 3 hours to complete.

If this test succeeds you will see the message: **Status: Hard Drive Functioning Properly.** If this test fails, you will see the message: **Hard Drive Error (#)**

Select **Back** to skip the test and return to the **Hardware Tests** menu.

Check File System

This test REBOOTS YOUR GAME and performs a low level systems check of the integrity of your hard drive.

Note: This can take several minutes.

Back

This will take you back to the **Hardware Tests** menu.



CHECK COOLING

This checks that your game is functioning at the proper temperature and all fans are working. The current status is color-coded for easy viewing. If the results are displayed in green, your cabinet is at normal settings.

Due to motherboard limitations, not all temperatures or fan speeds are available.

Back

The Back button takes you back to the **Hardware Tests** menu.

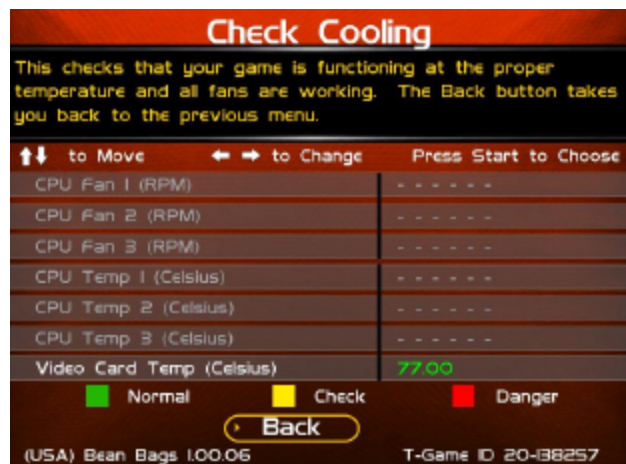

Note: Target Toss Pro: Bags is an offline system, without a connection to ITNet. Therefore, troubleshooting data, audits and operator adjustable items are NOT available online through your secure ITNet account.

TROUBLESHOOTING SHORTCUTS

This section gathers many of the commonly used tests and menus into one convenient area. Check here first when troubleshooting problems or questions about the integrity of your machine.

The tests that are available in this section are:

Check Cooling
Check Hard Drive
Hardware & Software
Player Control Tests
System Tests

Descriptions of each of these tests and sections can be found elsewhere in this manual.

Back

This will take you back to the **Main Menu**.



TARGET TOSS PRO SETTINGS & AUDITS

Player Cost Schedule

This option allows you to adjust the amount of money it costs a player to play various game types.

Game Audits

This area allows you to view your money audits, game purchase audits, and reset your collections and audits.

Game Options

This area allows you to adjust options specific to Target Toss: Bags.

Reset Leaderboards

This will clear all of the game's local leaderboards and high-score screens.

Exit

This will take you back to the **Main Menu**.



PLAYER COST SCHEDULE

This screen details the costs of various play selections. The player cost is shown as a total.

Individual Play

This option lets you adjust how much it costs a player to play a single game.

Tournament Play

This option lets you adjust how much it costs each player to play in a 4-man, 8-man or 16-man single-elimination bracketed contest.

Reset Values

This resets all values to their default value located on this page.

Back

Select this to return to the **Bags Settings & Audits** menu.



GAME AUDITS

This section displays various counts and totals for a variety of areas of interest. The following values are based on the last reset, the date of which is shown at the top of the screen.

Coin Slot 1 (All Machines)

Coin Slot 2 (Kits only)

Bill Acceptor

Lifetime Money In

This field shows how much total money your machine has made. This field is cumulative and is not affected by resetting the audits on this screen.



More

The available audits span a number of different screens. Selecting More brings you to the next page of audit information. There are three pages total of audits.



Reset Audits

This will reset the fields on this screen to zero, and update the date of the last audit reset. The Lifetime Money In field will not be affected by this function.

GAME OPTIONS

Game Options presents a variety of game-specific features that can be turned on or off based on the needs of your location.

Delay Timeout

This is the time allowed for each throw. If no input is noticed during this time period, the game will move on to the next turn. Default time for a bag is 25 seconds.

Timeout # Bags

This is the number of consecutive timeouts it takes to end a game and return to the attract mode.

Vegas Games

This is a selectable game mode that displays cards for every bag in the hole. Turn this option off in areas where the display of playing cards is not allowed.

Practice Bags

A one-player game allows for 1, 2, 3 or 4 practice throws before scoring begins. This is a nice way to introduce new players to the feel and play of the game. Turn this feature to Off if no practice bags are desired.

Reset Values

This will reset the fields on this screen to zero, and update the date of the last audit reset. The Lifetime Money In field will not be affected by this function.



RESET LEADERBOARDS

Use this menu to clear the leaderboards or high-score screens. You can reset individual leaderboards or all of them at once.

Inning Leaderboards

The highest score in one inning.

Top Baggers

The best complete game scores.

Team Leaderboard

Best two-player team scores

Hole-Shot Masters

Most hole-shots in a row.

Reset All Leaderboards

Use this to clear all leaderboards at one time.



TROUBLESHOOTING & REFERENCE

APPENDIX A TROUBLESHOOTING GUIDE

Video Problems		
Symptom	Probable Cause	Solution
No picture on 27" Monitor	I/O Board Dip Switch settings are wrong.	Adjust Dip Switch settings to match the resolution of the monitor you are using. Refer to I/O Dip Switch Settings in Appendix D.
	Incorrect video connection configuration.	Be sure the video connections are correct according to the type of monitor you are using. Refer to the diagrams in Appendix D.
	Monitor does not have a proper A.C. voltage input.	Verify A.C. power to the Nighthawk System box. Verify monitor is working on a known good system.
	Monitor is defective.	Repair or replace.
	Nighthawk System box is defective	Go to Nighthawk System box troubleshooting section.
No picture but game sounds are heard	Incorrect video connection configuration.	Verify video is connected to the system correctly. Refer to the diagrams in Appendix D.
	Since you hear game sounds the system is working.	Review no picture troubleshooting section above.
Scrambled Picture	I/O board Dip Switch settings are set wrong.	Adjust Dip Switch settings to match the resolution of the monitor you are using. Refer to Dip Switch Settings in Appendix D.
	Incorrect video connection configuration.	Be sure the video connections are correct according to the type of monitor you are using. Refer to the diagrams in Appendix D.
Entire picture is not seen on the screen or it does not fill the entire screen	Misadjusted monitor.	Adjust the monitor width and height. Use video screen adjustment in system tests. Refer to the monitor manual.
Missing or washed out colors	Bad Video connections	Verify continuity from the monitor to the video out on the I/O board. Red, Green, Blue video signal. <i>Mid. and Low resolution monitors only.</i>
	Contrast and brightness on the monitor needs to be adjusted.	Refer to the monitor manual to make adjustments.
	Defective Monitor.	Verify by connecting a known good monitor to the system.

Sound Problems		
Symptom	Probable Cause	Solution
No Sound	Audio Cable between the I/O board and the Nighthawk system box are not connected.	Verify audio cables are connected. Refer to Appendix D.
	Speakers are not connected properly.	Verify continuity from the I/O board speaker output pins to the speakers. Refer to Appendix D.
	Volume is set to the lowest level.	Adjust the volume to an audible level.
	Attract mode sounds may be set to all off. You will have sounds when playing the game.	Choose one of the 5 Attract Mode sound options in Sound Adjustments.
	Defective I/O board.	Verify on a known working system. Replace if necessary.
	Defective Nighthawk system box.	Be certain all other possibilities are explored before replacing the Nighthawk system box.
Distorted or scratchy game sounds	Bad speaker.	Replace blown speaker.
	Loose speaker or grill cover is causing vibration.	Verify all components are installed properly and securely.
	Loose/defective audio cables from the Nighthawk system box to the I/O board.	Check the audio cable connections. Replace cable.
	Defective I/O board.	Verify on a known working system. Replace if necessary.
	Defective Nighthawk system box.	Be certain all other possibilities are explored before replacing the Nighthawk system box.

Nighthawk System Box Problems		
Symptom	Probable Cause	Solution
No video and no green lights on the I/O board. Fans are not heard on the Nighthawk System box.	No A.C. power to the Nighthawk system box.	Verify A.C. voltage is connected to the Nighthawk system box.
	Power switch on the Nighthawk system box is off.	Flip the Nighthawk system box power switch to on.
	Main cabinet power switch is off.	Be certain the main cabinet switch is set to on.
	Defective Nighthawk system box.	Be certain all other possibilities are explored before replacing the Nighthawk system box.
No video and no green lights on the I/O board. Fans are heard on the Nighthawk System box.	DC power cord not connected from Nighthawk system box to I/O board.	Connect the DC power cord from the Nighthawk system box to the I/O board.
	Defective I/O board.	Try it on a known good system. Verify by disconnecting all cables from the I/O board except the DC power and USB cable to the Nighthawk system box. No green lights, replace the I/O board.

Control Problems		
Symptom	Probable Cause	Solution
Button does not work.	Switches Common post is not connected to digital ground.	Verify continuity to digital/power supply ground.
	Signal wire is not connected to the Normally Open post of the switch.	Verify continuity from the I/O board to the Normally Open post of the switch.
	Switch is defective.	Replace defective switch.
Button always indicates closed in the player control test. Pressing it will show it is not depressed.	Signal wire is connected to the Normally Closed post of the switch.	Connect signal wire to the Normally Open post of the switch.
Button always indicates closed in player control test even with the switch disconnected entirely.	Defective I/O board.	Test on a known good system. Replace if necessary.
Trackball is not functioning in any direction.	Trackball is not connected to the I/O board properly.	Verify the trackball is connected to J208 labeled trackball on the I/O board.
	Defective trackball Interconnect cable.	Verify continuity on the trackball Interconnect cable.
	Trackball is defective.	Replace trackball.
	I/O board is defective	Replace I/O board. Try it on a known good system.
Trackball does not work in a certain direction.	Trackball cable is defective.	Verify continuity on the trackball cable. Repair or replace if needed.
	Trackball is defective.	Repair or replace the trackball. Try it on a known working system.
	I/O board is defective.	Repair or replace the I/O board. Try it on a known working system.
Trackball works intermittently.	Inside of the trackball is dirty.	Clean the inside of the trackball.
	Rollers are worn.	Replace the rollers and bearings.
	Trackball is over-tightened.	Do not over-tighten the trackball. Tighten just enough to flatten the lock washers.

Flash Code Messages		
<i>Flash Code (I/O Diode D102)</i>	<i>Code Description</i>	<i>Solution</i>
Flash Code 2	Possible IO board failure	First Check Connections. Turn off game, wait 10 seconds, turn game on. If Problem persists call IT tech support.
Flash Code 3	Info: Last reboot due to Watchdog time out.	Turn off game, wait 10 seconds, turn game on. If Problem persists call IT tech support.
Flash Code 4	Error When updating CID to latest Version	Typically CID failure. Turn off game, wait 10 seconds, turn game on. If Problem persists call IT tech support.
Flash Code 5	Updated USB CID was detected. This is not an error but a notification.	Turn off game, wait 10 seconds, turn game on. If Problem persists call IT tech support.
Flash Code 6	Disconnected Cabinet ID Device (CID) was detected.	Check USB connection. Turn off game, wait 10 seconds, turn game on. If Problem persists call IT tech support.
Flash Code 7	CID Malfunction. Typically CID is defective.	Turn off game, wait 10 seconds, turn game on. If Problem persists call IT tech support.
Flash Code 10	Error When updating USB IO board to latest version. Typically an IO board failure	Turn off game, wait 10 seconds, turn game on. If Problem persists call IT tech support.
Flash Code 11	Updated USB IO board to latest version. This is not an error but a notification.	Turn off game, wait 10 seconds, turn game on. If Problem persists call IT tech support.
Flash Code 12	A disconnected IO board was detected.	Turn off game, Check USB and power connections, turn game on. If Problem persists call IT tech support.
Flash Code 13	IO board malfunction. Typically IO board has failed.	Turn off game, wait 10 seconds, turn game on. If Problem persists call IT tech support.
Flash Code 14	Game is incompatible with USB IO board.	This usually means the wrong type of IO board. It does not match the system box software. Try turning off game, wait 10 seconds, turn game on. If problem persists call IT tech support.

Miscellaneous Problems		
<i>Symptom</i>	<i>Probable Cause</i>	<i>Solution</i>
Unable to exit Operator Menus.	Dipswitch SW202 position 4 is in the on position.	Set position 4 of SW202 to off. Press start to exit.
	Test switch wired from the I/O board is closed.	Verify satellite test switch is not closed.
No fluorescent light	No 120 volts A.C. power going to the light fixture.	Verify A.C. voltage to the light fixture.
	Defective fluorescent light.	Replace fluorescent light.
	Defective starter	Replace the starter.
	Defective ballast.	Replace the ballast.
Coin Meter is not working	Defective Coin Meter	Replace with a known good one.
	Not wired properly	Connect one lead to +5 or +12 volts depending on device. The other lead to count 1 on the JAMMA connector.
	Defective I/O board	Replace with a known good board.

APPENDIX B JAMMA, TRACKBALL, AND I/O POWER CONNECTIONS

JAMMA Harness Connection

SOLDER SIDE			PARTS SIDE		
WIRE COLOR	FUNCTION		FUNCTION	WIRE COLOR	
	*	A	1	*	
	*	B	2	*	
	*	C	3	*	
	*	D	4	*	
		E	5		
	*	F	6	*	
KEY		H	7	KEY	
	Count 2	J	8	Coin Counter	Red-Green
		K	9		
Yellow-Green	Left Speaker (-)	L	10	Left Speaker (+)	Yellow-Red
White-Green	Right Speaker (-)	M	11	Right Speaker (+)	White-Red
Green-Black	Video Green	N	12	Video Red	Red-Black
White	Video Sync	P	13	Video Blue	Blue-Black
		R	14	Video GND	White-Black
		S	15	Test	Blue
Green-Blue	Coin 2	T	16	Coin1	Red-Blue
		U	17	Start /Options	Red-White
		V	18		
		W	19		
		X	20	Shot Type	Black-White
		Y	21		
		Z	22	Down – Low Toss	Brown-White
		a	23	Up – High Toss	Yellow-White
Orange-Yellow	Volume Down	b	24	Volume Up	Orange-White
		c	25	Coin 3 (Bill)	Gray-White
		d	26		
Black	GND	e	27	GND	Black
Black	GND	f	28	GND	Black

***NOTE: Power is NOT routed through the JAMMA connector.**

Trackball Harness Connector Pin Outs

I/O Board Connector	Trackball Connector
PIN WIRE #6 - Black	PIN WIRE #1 – Black
PIN WIRE #1 - Red	PIN WIRE #2 – Red
PIN WIRE #2 - Yellow	PIN WIRE #3 – Yellow
PIN WIRE #3 - Green	PIN WIRE #4 – Green
PIN WIRE #5 - Blue	PIN WIRE #5 – Blue
PIN WIRE #4 - Purple	PIN WIRE #6 – Purple

I/O Power Cable Pin Outs

Pin Number	Wire Color	Function
1	Yellow	+ 12 Volts DC
2	Black	Ground
3	Red	+ 5 Volts DC
4	Black	Ground

APPENDIX C REPLACEMENT PART NUMBERS

Please refer to these IT part numbers when placing orders.

Part Number	Description
960000291	CABINET, DEDICATED TARGET TOSS PRO
900206007R	CABINET IDENTIFICATION DEVICE, TARGET TOSS PRO
915000285	CABLE ASSY, AUDIO CABLE, 6 FT 2RCA PLUG TO 2RCA PLUG
915250204	CABLE ASSY, I/O POWER FOR KITS
915000745	CABLE ASSY, POWER CORD. A.C.
915000315	CABLE ASSY, SVGA, 6 FT. DB15HD M-M
915000310	CABLE ASSY, USB CABLE, 6 FT.
915000173	CABLE ASSY, TRACKBALL/GUN INTERFACE
999000060	CARD READER BLANKING PLATE
938291715	CASH VAULT COMPLETE ASSEMBLY W/ \$1-5 DBA FOR TARGET TOSS PRO
900291100	CONTROL PANEL, TTP BAGS, FULLY DRESSED SUB ASSY FOR IT CABINETS
845000291K	CONTROL PANEL, DIECUT PLEXI W/ADHESIVE SQUARE
845000291	CONTROL PANEL PLEXI FOR TARGET TOSS PRO DEDICATED ONLY
825100291	CONTROL PANEL OVERLAY GRAPHIC, DIECUT WITH CONTROL LABELS/TB HOLE
753000250	CONTROL PANEL RUBBER BUMPER FOR TARGET TOSS PRO DEDICATED
999000288	DBA, MARS \$1-5 BILL ACCEPTOR FOR IT CASH VAULT ONLY MODEL AE2481D5E
925000291D	DEDICATED, US TARGET TOSS PRO: BAGS COMPLETE UNIT
900900020	I/O BOARD FOR TARGET TOSS PRO DEDICATED
900000020	I/O BOARD FOR TARGET TOSS PRO KIT
840000000	IT LOGO CARD FOR NON-TOURN. CABINETS
925000291	KIT – TARGET TOSS PRO OFFLINE
925000291CP	KIT – TARGET TOSS PRO OFFLINE WITH DRESSED CONTROL PANEL
815000291	MANUAL, TARGET TOSS PRO BAGS
820000291	MARQUEE, TARGET TOSS PRO BAGS
850000001	PUSHBUTTON ASSY, RED WITH VERTICAL MOUNTED SWITCH
850000003	PUSHBUTTON ASSY, WHITE WITH VERTICAL MOUNTED SWITCH
840000291	QUICK INSTALL GUIDE, TARGET TOSS PRO BAGS
830000291	SIDE DECAL, TARGET TOSS PRO
900000291	SYSTEM BOX, TARGET TOSS PRO
753000500	SYSTEM BOX FILTER
752259500	SYSTEM BOX FILTER BRACKET
880000030	TRACKBALL ASSY, 3" WHITE
885000030	TRACKBALL PLATE FOR 3" TRACKBL WITH STANDOFFS

APPENDIX D NIGHTHAWK COMPONENT DIAGRAMS

Nighthawk System Box Diagram

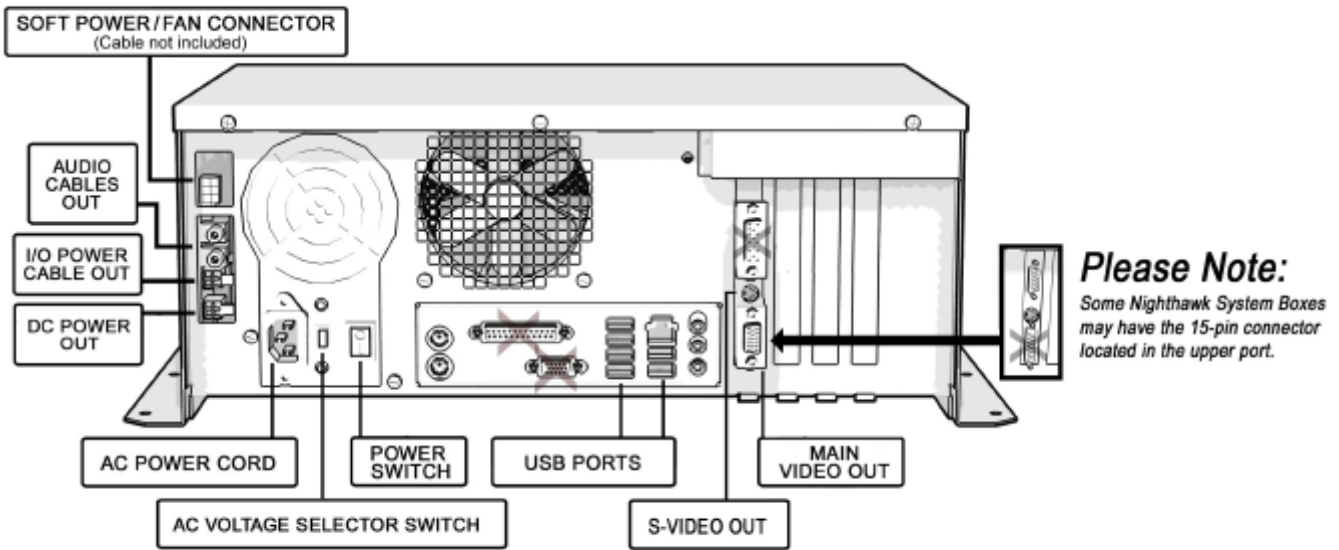

Dedicated I/O Board Diagram

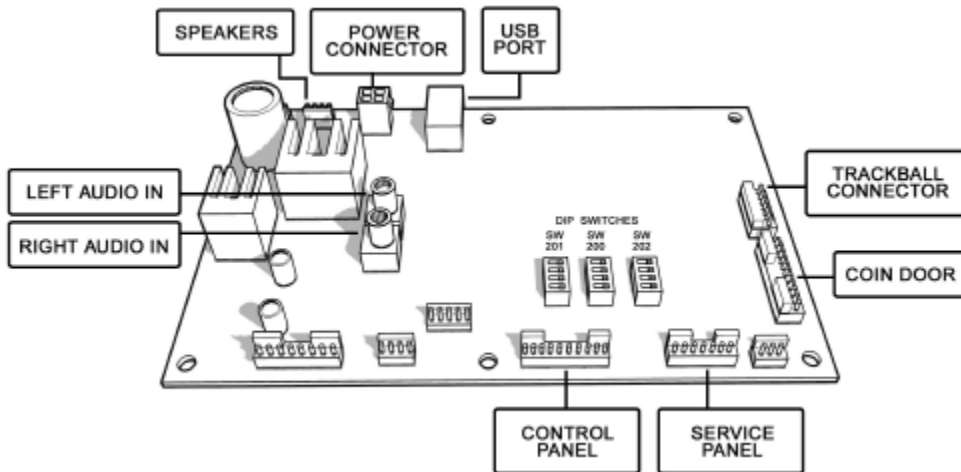

Kit I/O Board Diagram

This I/O Board accepts a JAMMA connector.

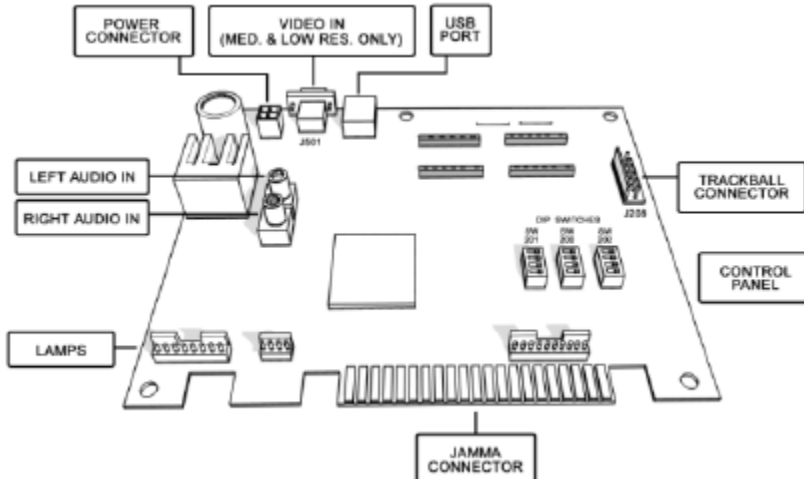

Detailed Cable Connection Diagram

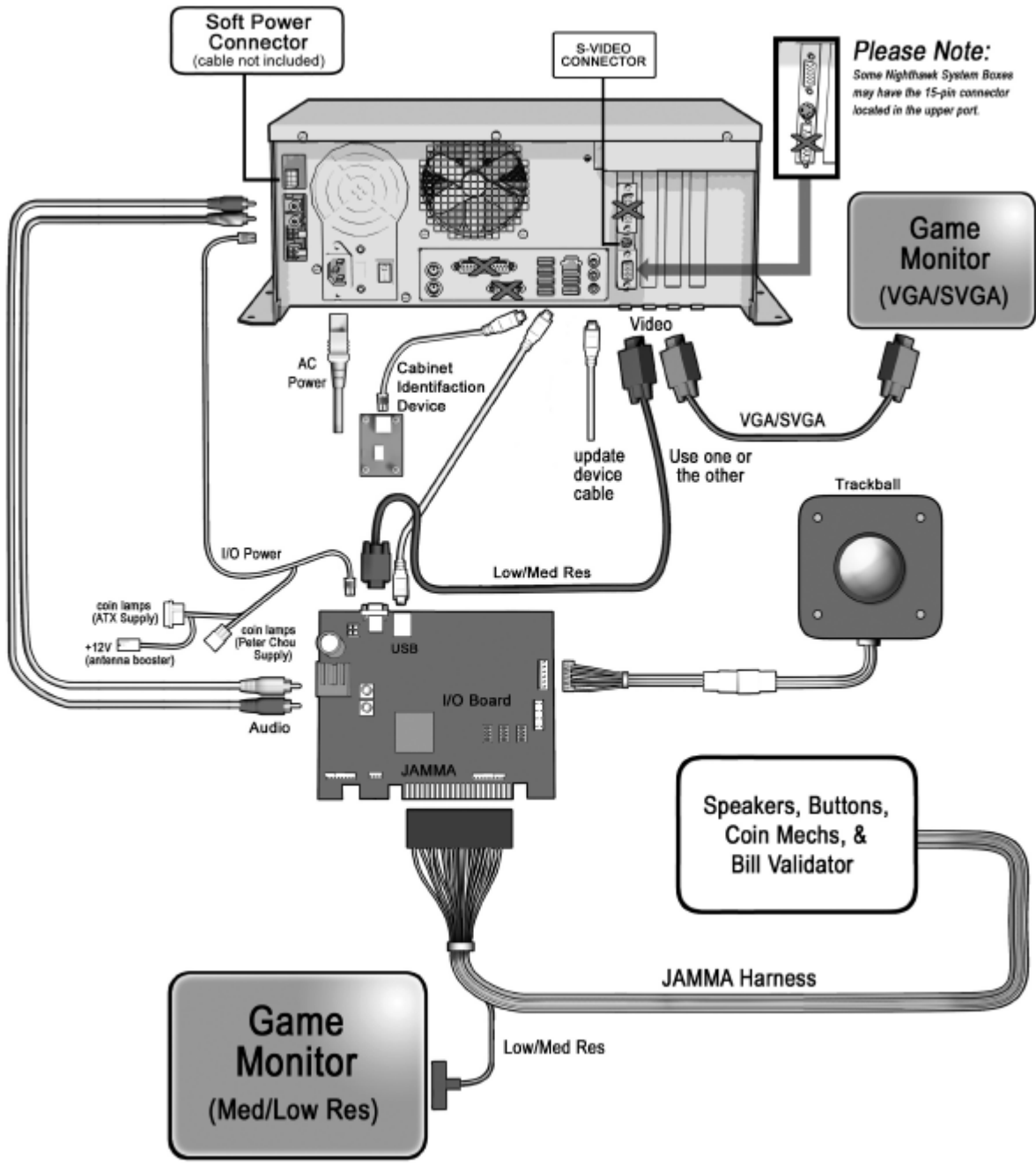

Video and I/O Dip Switch Settings

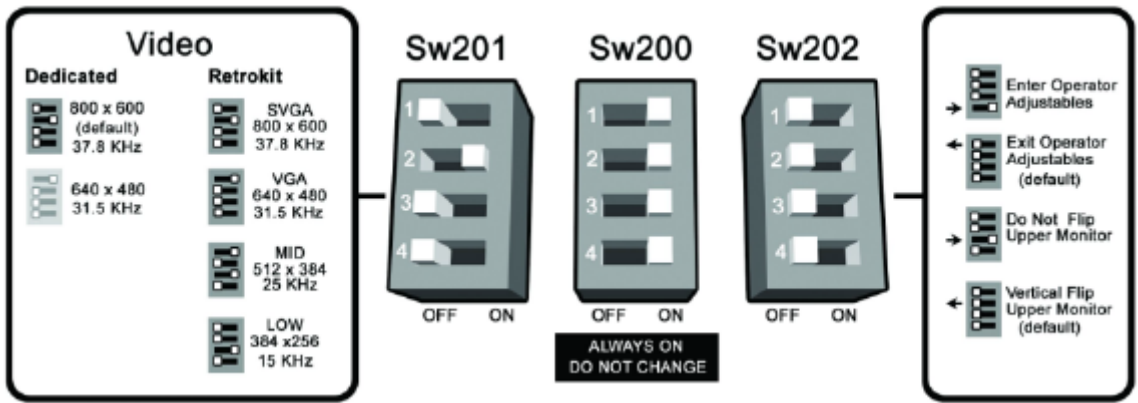

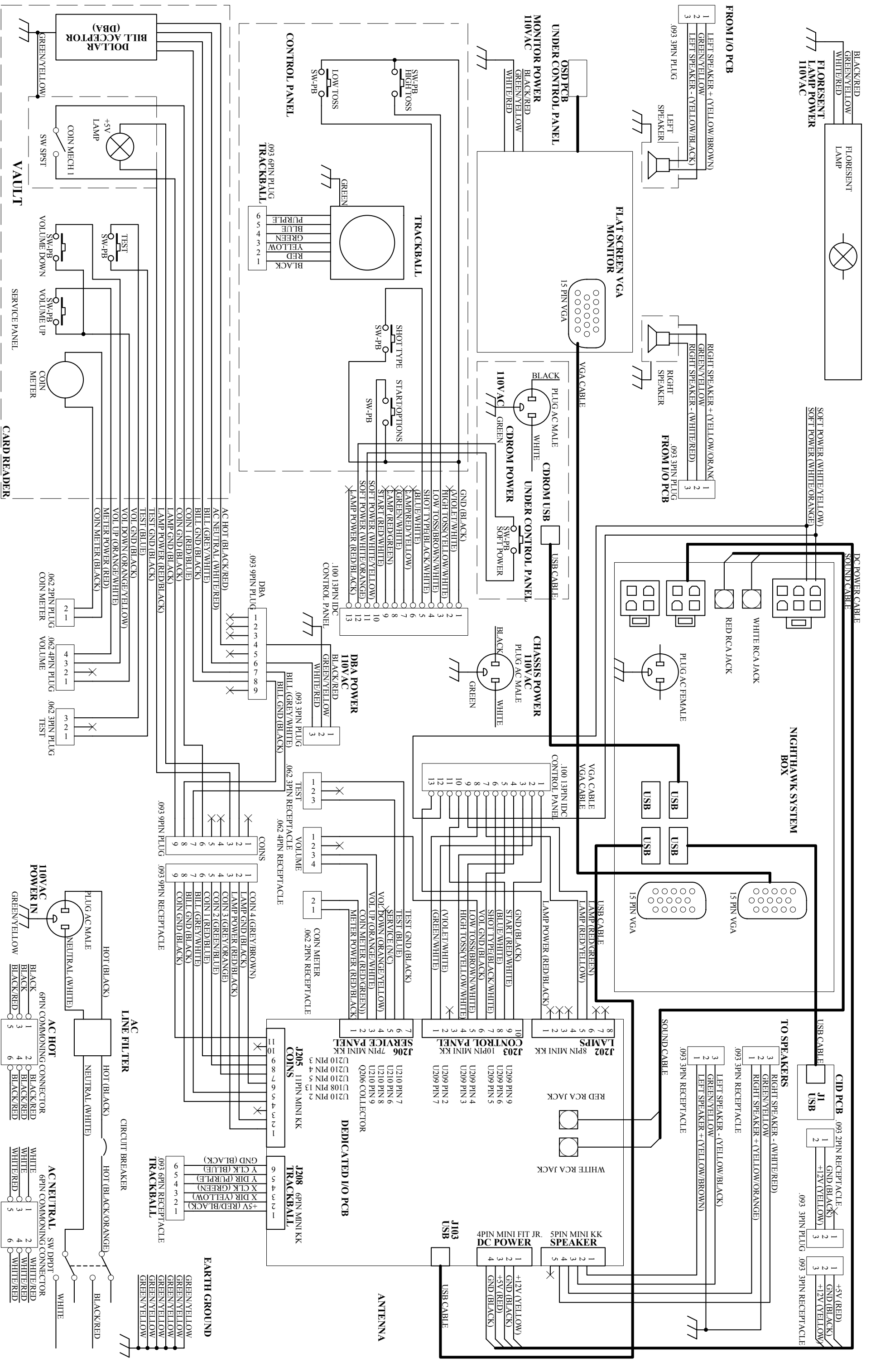

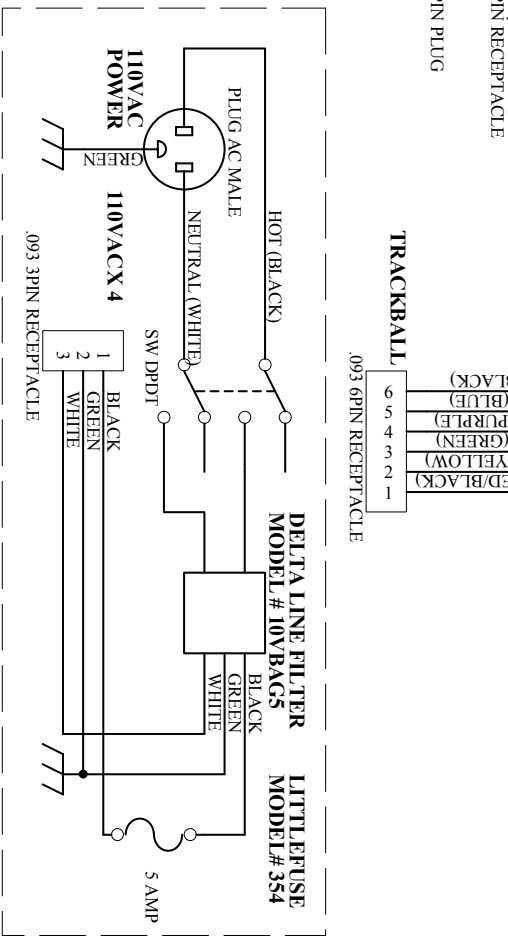
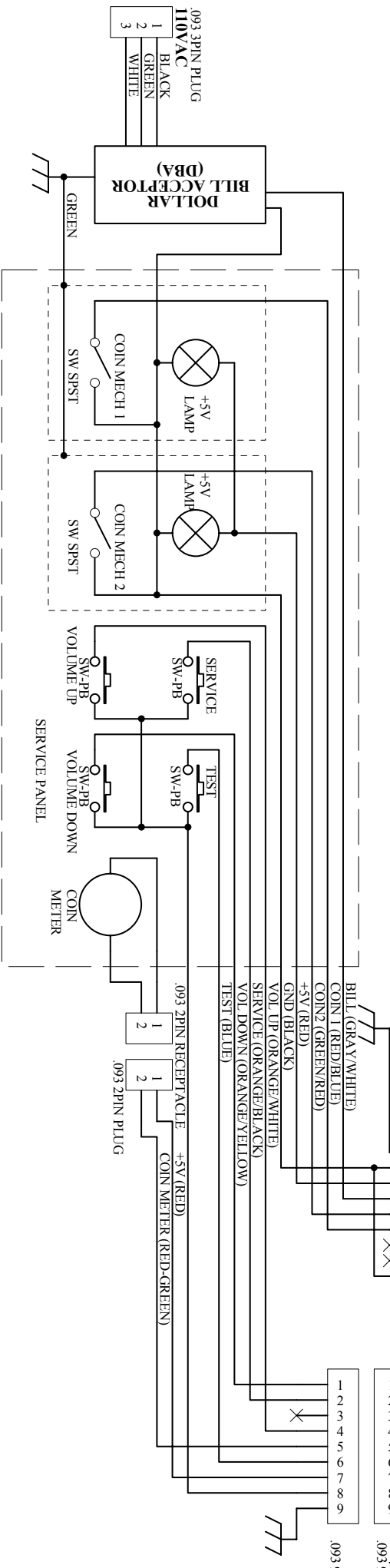
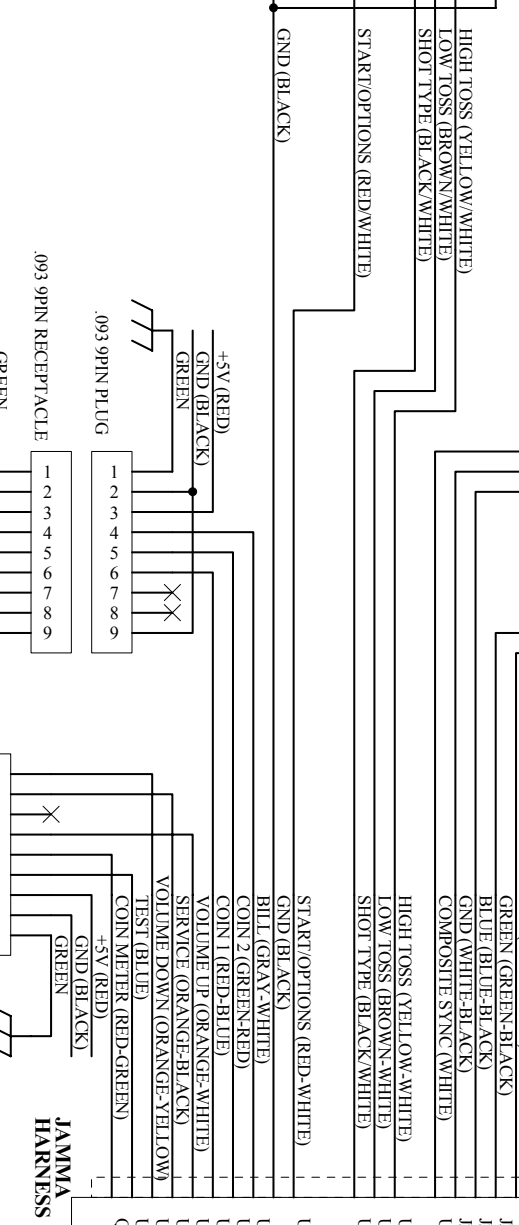
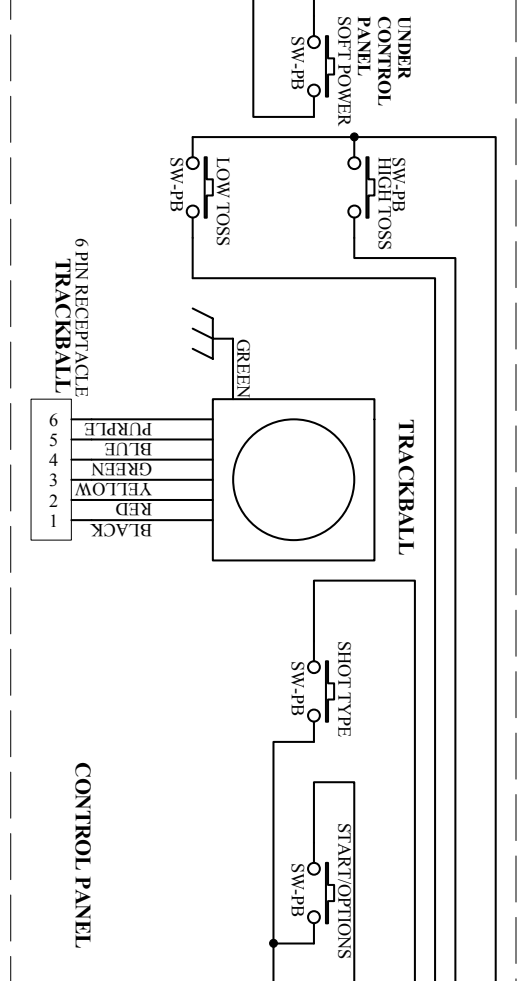
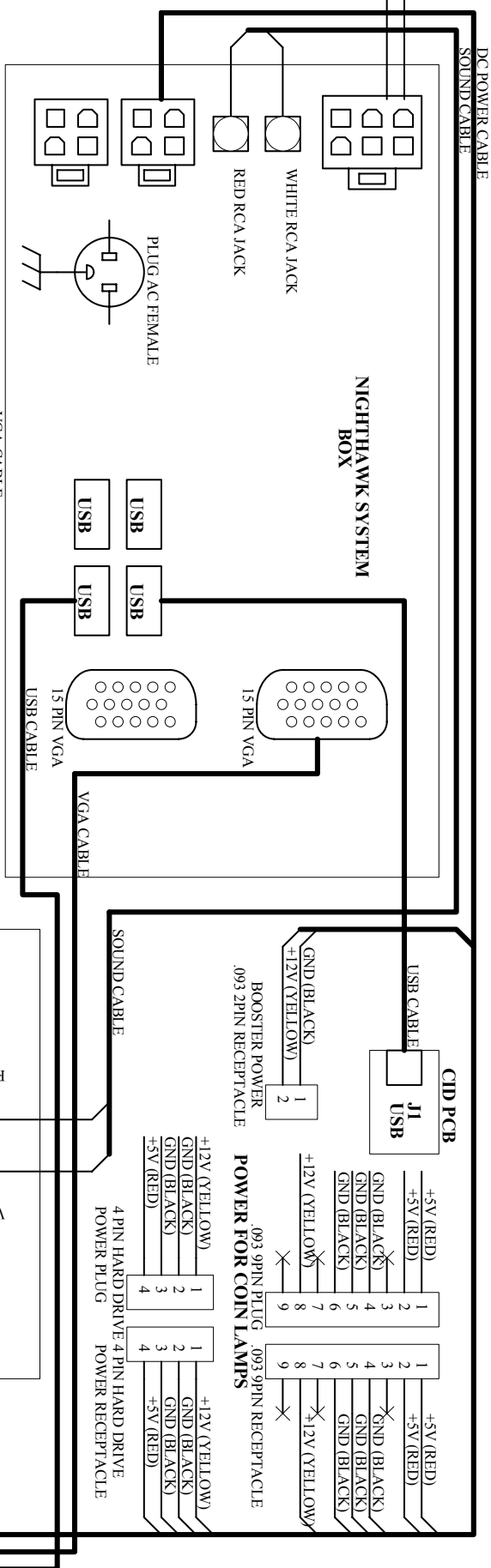
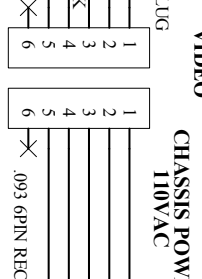
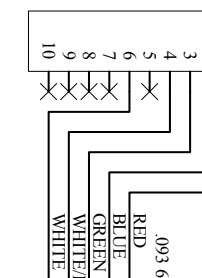
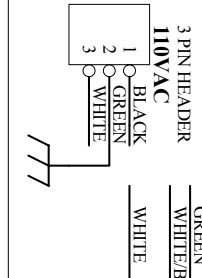
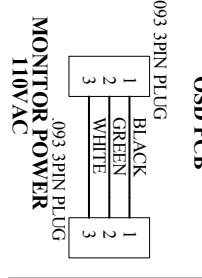
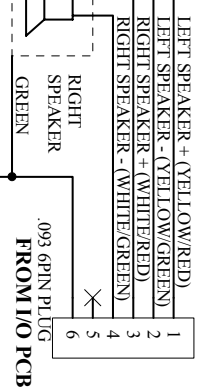
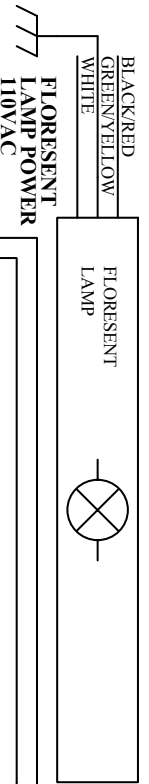
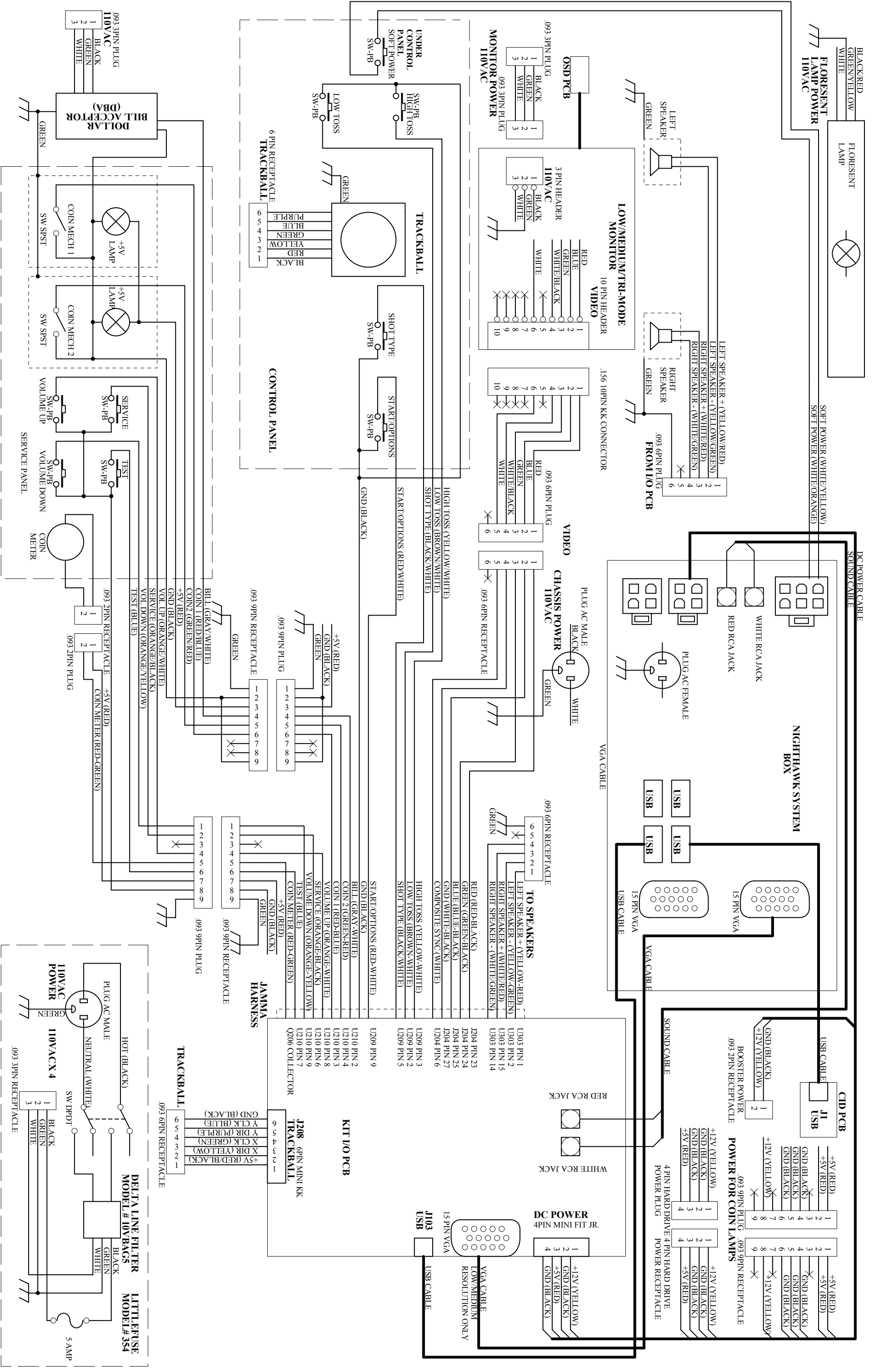

APPENDIX E

GNU GENERAL PUBLIC LICENSE

TERMS AND CONDITIONS FOR COPYING, DISTRIBUTION AND MODIFICATION

0. This License applies to any program or other work which contains a notice placed by the copyright holder saying it may be distributed under the terms of this General Public License. The "Program", below, refers to any such program or work, and a "work based on the Program" means either the Program or any derivative work under copyright law: that is to say, a work containing the Program or a portion of it, either verbatim or with modifications and/or translated into another language. (Hereinafter, translation is included without limitation in the term "modification".) Each licensee is addressed as "you".

Activities other than copying, distribution and modification are not covered by this License; they are outside its scope. The act of running the Program is not restricted, and the output from the Program is covered only if its contents constitute a work based on the Program (independent of having been made by running the Program). Whether that is true depends on what the Program does.

1. You may copy and distribute verbatim copies of the Program's source code as you receive it, in any medium, provided that you conspicuously and appropriately publish on each copy an appropriate copyright notice and disclaimer of warranty; keep intact all the notices that refer to this License and to the absence of any warranty; and give any other recipients of the Program a copy of this License along with the Program.

You may charge a fee for the physical act of transferring a copy, and you may at your option offer warranty protection in exchange for a fee.

2. You may modify your copy or copies of the Program or any portion of it, thus forming a work based on the Program, and copy and distribute such modifications or work under the terms of Section 1 above, provided that you also meet all of these conditions:

- a) You must cause the modified files to carry prominent notices stating that you changed the files and the date of any change.
- b) You must cause any work that you distribute or publish, that in whole or in part contains or is derived from the Program or any part thereof, to be licensed as a whole at no charge to all third parties under the terms of this License.
- c) If the modified program normally reads commands interactively when run, you must cause it, when started running for such interactive use in the most ordinary way, to print or display an announcement including an appropriate copyright notice and a notice that there is no warranty (or else, saying that you provide a warranty) and that users may redistribute the program under these conditions, and telling the user how to view a copy of this License. (Exception: if the Program itself is interactive but does not normally print such an announcement, your work based on the Program is not required to print an announcement.) These requirements apply to the modified work as a whole. If identifiable sections of that work are not derived from the Program, and can be reasonably considered independent and separate works in themselves, then this License, and its terms, do not apply to those sections when you distribute them as separate works. But when you distribute the same sections as part of a whole which is a work based on the Program, the distribution of the whole must be on the terms of this License, whose permissions for other licensees extend to the entire whole, and thus to each and every part regardless of who wrote it.

Thus, it is not the intent of this section to claim rights or contest your rights to work written entirely by you; rather, the intent is to exercise the right to control the distribution of derivative or collective works based on the Program.

In addition, mere aggregation of another work not based on the Program with the Program (or with a work based on the Program) on a volume of a storage or distribution medium does not bring the other work under the scope of this License.

3. You may copy and distribute the Program (or a work based on it, under Section 2) in object code or executable form under the terms of Sections 1 and 2 above provided that you also do one of the following:

- a) Accompany it with the complete corresponding machine-readable source code, which must be distributed under the terms of Sections 1 and 2 above on a medium customarily used for software interchange; or,
- b) Accompany it with a written offer, valid for at least three years, to give any third party, for a charge no more than your cost of physically performing source distribution, a complete machine-readable copy of the corresponding source code, to be distributed under the terms of Sections 1 and 2 above on a medium customarily used for software interchange; or,
- c) Accompany it with the information you received as to the offer to distribute corresponding source code. (This alternative is allowed only for noncommercial distribution and only if you received the program in object code or executable form with such an offer, in accord with Subsection b above.)

The source code for a work means the preferred form of the work for making modifications to it. For an executable work, complete source code means all the source code for all modules it contains, plus any associated interface definition files, plus the scripts used to control compilation and installation of the executable. However, as a special exception, the source code distributed need not include anything that is normally distributed (in either source or binary form) with the major components (compiler, kernel, and so on) of the operating system on which the executable runs, unless that component itself accompanies the executable.

If distribution of executable or object code is made by offering access to copy from a designated place, then offering equivalent access to copy the source code from the same place counts as distribution of the source code, even though third parties are not compelled to copy the source along with the object code.

4. You may not copy, modify, sublicense, or distribute the Program except as expressly provided under this License. Any attempt otherwise to copy, modify, sublicense or distribute the Program is void, and will automatically terminate your rights under this License. However, parties who have received copies, or rights, from you under this License will not have their licenses terminated so long as such parties remain in full compliance.

5. You are not required to accept this License, since you have not signed it. However, nothing else grants you permission to modify or distribute the Program or its derivative works. These actions are prohibited by law if you do not accept this License. Therefore, by modifying or distributing the Program (or any work based on the Program), you indicate your acceptance of this License to do so, and all its terms and conditions for copying, distributing or modifying the Program or works based on it.

6. Each time you redistribute the Program (or any work based on the Program), the recipient automatically receives a license from the original licensor to copy, distribute or modify the Program subject to these terms and conditions. You may not impose any further restrictions on the recipients' exercise of the rights granted herein. You are not responsible for enforcing compliance by third parties to this License.

7. If, as a consequence of a court judgment or allegation of patent infringement or for any other reason (not limited to patent issues), conditions are imposed on you (whether by court order, agreement or otherwise) that contradict the conditions of this License, they do not excuse you from the conditions of this License. If you cannot distribute so as to satisfy simultaneously your obligations under this License and any other pertinent obligations, then as a consequence you may not distribute the Program at all. For example, if a patent license would not

permit royalty-free redistribution of the Program by all those who receive copies directly or indirectly through you, then the only way you could satisfy both it and this License would be to refrain entirely from distribution of the Program.

If any portion of this section is held invalid or unenforceable under any particular circumstance, the balance of the section is intended to apply and the section as a whole is intended to apply in other circumstances.

It is not the purpose of this section to induce you to infringe any patents or other property right claims or to contest validity of any such claims; this section has the sole purpose of protecting the integrity of the free software distribution system, which is implemented by public license practices. Many people have made generous contributions to the wide range of software distributed through that system in reliance on consistent application of that system; it is up to the author/donor to decide if he or she is willing to distribute software through any other system and a licensee cannot impose that choice.

This section is intended to make thoroughly clear what is believed to be a consequence of the rest of this License.

8. If the distribution and/or use of the Program is restricted in certain countries either by patents or by copyrighted interfaces, the original copyright holder who places the Program under this License may add an explicit geographical distribution limitation excluding those countries, so that distribution is permitted only in or among countries not thus excluded.

In such case, this License incorporates the limitation as if written in the body of this License.

9. The Free Software Foundation may publish revised and/or new versions of the General Public License from time to time. Such new versions will be similar in spirit to the present version, but may differ in detail to address new problems or concerns.

Each version is given a distinguishing version number. If the Program specifies a version number of this License which applies to it and "any later version", you have the option of following the terms and conditions either of that version or of any later version published by the Free Software Foundation. If the Program does not specify a version number of this License, you may choose any version ever published by the Free Software Foundation.

10. If you wish to incorporate parts of the Program into other free programs whose distribution conditions are different, write to the author to ask for permission. For software which is copyrighted by the Free Software Foundation, write to the Free Software Foundation; we sometimes make exceptions for this. Our decision will be guided by the two goals of preserving the free status of all derivatives of our free software and of promoting the sharing and reuse of software generally.

NO WARRANTY

11. BECAUSE THE PROGRAM IS LICENSED FREE OF CHARGE; THERE IS NO WARRANTY FOR THE PROGRAM, TO THE EXTENT PERMITTED BY APPLICABLE LAW. EXCEPT WHEN OTHERWISE STATED IN WRITING THE COPYRIGHT HOLDERS AND/OR OTHER PARTIES PROVIDE THE PROGRAM "AS IS" WITHOUT WARRANTY OF ANY KIND, EITHER EXPRESSED OR IMPLIED, INCLUDING, BUT NOT LIMITED TO, THE IMPLIED WARRANTIES OF MERCHANTABILITY AND FITNESS FOR A PARTICULAR PURPOSE. THE ENTIRE RISK AS TO THE QUALITY AND PERFORMANCE OF THE PROGRAM IS WITH YOU. SHOULD THE PROGRAM PROVE DEFECTIVE, YOU ASSUME THE COST OF ALL NECESSARY SERVICING, REPAIR OR CORRECTION.

12. IN NO EVENT UNLESS REQUIRED BY APPLICABLE LAW OR AGREED TO IN WRITING WILL ANY COPYRIGHT HOLDER, OR ANY OTHER PARTY WHO MAY MODIFY AND/OR REDISTRIBUTE THE PROGRAM AS PERMITTED ABOVE, BE LIABLE TO YOU FOR DAMAGES, INCLUDING ANY GENERAL, SPECIAL, INCIDENTAL OR CONSEQUENTIAL DAMAGES ARISING OUT OF THE USE OR INABILITY TO USE THE PROGRAM (INCLUDING BUT NOT LIMITED TO LOSS OF DATA OR DATA BEING RENDERED INACCURATE OR LOSSES SUSTAINED BY YOU OR THIRD PARTIES OR A FAILURE OF THE PROGRAM TO OPERATE WITH ANY OTHER PROGRAMS), EVEN IF SUCH HOLDER OR OTHER PARTY HAS BEEN ADVISED OF THE POSSIBILITY OF SUCH DAMAGES.

How to Apply These Terms to Your New Programs If you develop a new program, and you want it to be of the greatest possible use to the public, the best way to achieve this is to make it free software which everyone can redistribute and change under these terms.

To do so, attach the following notices to the program. It is safest to attach them to the start of each source file to most effectively convey the exclusion of warranty; and each file should have at least the "copyright"

line and a pointer to where the full notice is found.

One line to give the program's name and an idea of what it does.

Copyright (C) yyyy name of author

This program is free software; you can redistribute it and/or modify it under the terms of the GNU General Public License as published by the Free Software Foundation; either version 2 of the License, or (at your option) any later version.

This program is distributed in the hope that it will be useful, but WITHOUT ANY WARRANTY; without even the implied warranty of MERCHANTABILITY or FITNESS FOR A PARTICULAR PURPOSE. See the GNU General Public License for more details.

You should have received a copy of the GNU General Public License along with this program; if not, write to the Free Software Foundation, Inc., 59 Temple Place - Suite 330, Boston, MA 02111-1307, USA.

Copyright 2004 Incredible Technologies, Inc. (IT). Certain programs, identified at IT's Website are free software subject to an associated license.

1. Because certain programs are licensed free of charge, see it's website, there is no warranty for such programs to the extent permitted by applicable law. Except when otherwise stated in writing the copyright holders and/or other parties provide those programs "as is" without warranty of any kind, either expressed or implied, including, but not limited to, the implied warranties of merchantability and fitness for a particular purpose. The entire risk as to the quality and performance of those programs is with you. Should the programs prove defective, you assume the cost of all necessary servicing, repair or correction.

2. In no event unless required by applicable law or agreed to in writing will any copyright holder, or any other party who may modify and/or redistribute those programs be liable to you for damages including any general, special, incidental or consequential damages arising out of the use or inability to use those programs (including but not limited to loss of data or data being rendered inaccurate or losses sustained by you or third parties or a failure of those programs to operate with any other programs), even if such holder or other party has been advised of the possibility of such damages.

A complete machine-readable copy of the source code of those programs and associated license is available to any third party, at the it website.

APPENDIX F MENU NAVIGATION SHORTCUTS

Change Collection Settings

- Push the red System Setup button inside the coin door
- Select **General Settings** menu
- Select **Operator Adjustables** menu
- Select **Collection Settings** menu
- Select the menu that you want changed

Add Operator Free Cash

- Push the red System Setup button inside the coin door
- Select **Collection and Earnings**
- Select **Add Free Cash**
- Move the trackball left/right to select the desired dollar amount

GAME ICON DESCRIPTIONS

Cooling Icon

The cooling icon (pictured right) will appear in the game's attract mode to warn you that a fan is not operating at minimum recommended standards. If the fans do not operate at suggested levels it may cause your game to overheat and fail.

Call Incredible Technologies Technical Support at 847-870-7027 x121 for assistance.



**APPENDIX G
MOUNTING TEMPLATES**



MONITOR
DIRECTION

TRACKBALL ORIENTATION DIAGRAM

(VIEWED FROM UNDERSIDE OF CONTROL PANEL)

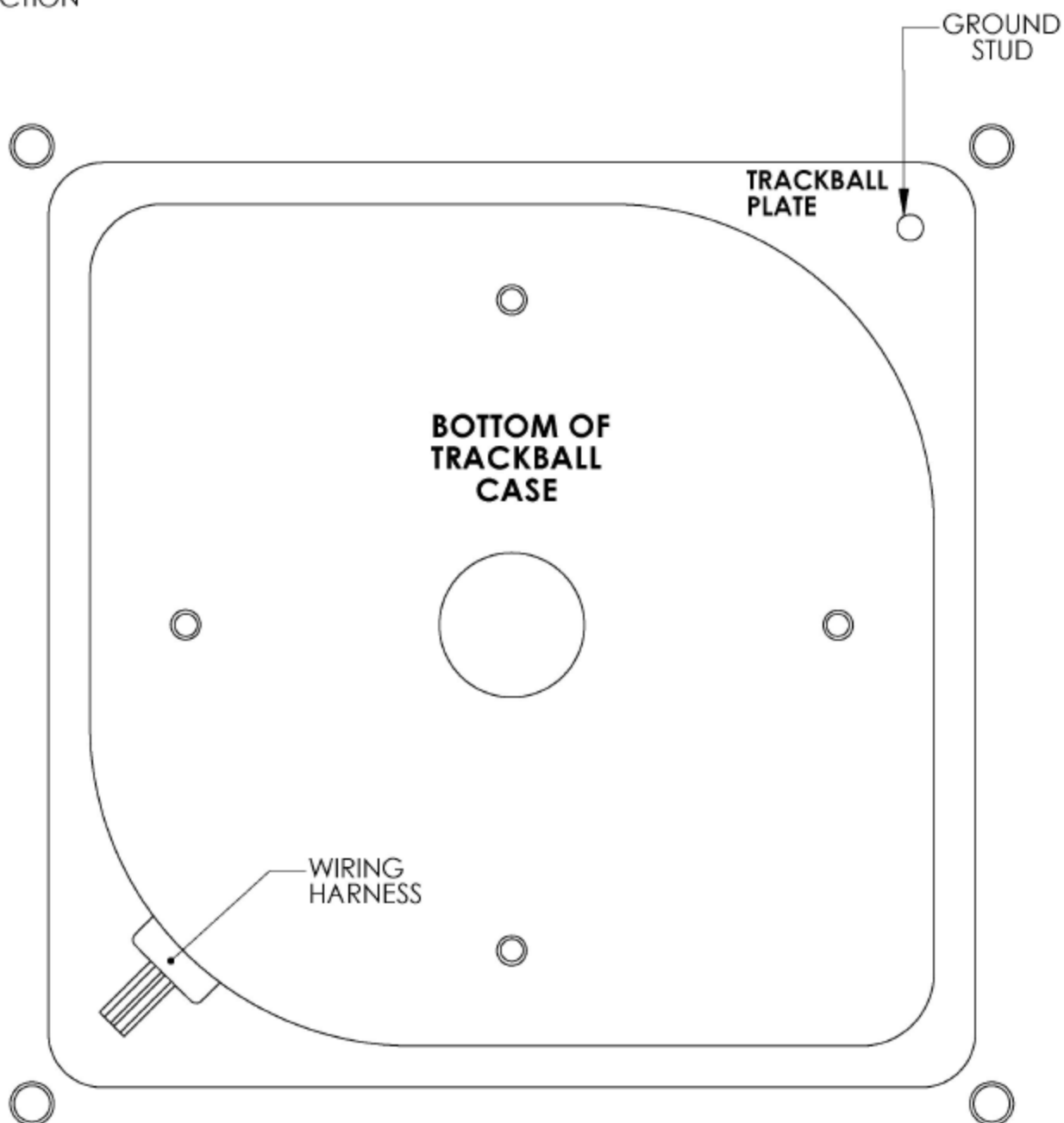

INSTALLATION NOTES:

- 1) THE WIRING HARNESS SHOULD POINT AWAY FROM THE MONITOR AND TO THE LEFT.
- 2) GROUND PIN SHOULD BE TOWARD THE MONITOR AND ON THE RIGHT SIDE.

TRACKBALL MOUNTING TEMPLATE

TOOLS REQUIRED:

DRILL, 9/32" OR 5/16" & 3/4" DRILL BITS, SABRE SAW, SCISSORS, & ROUTER

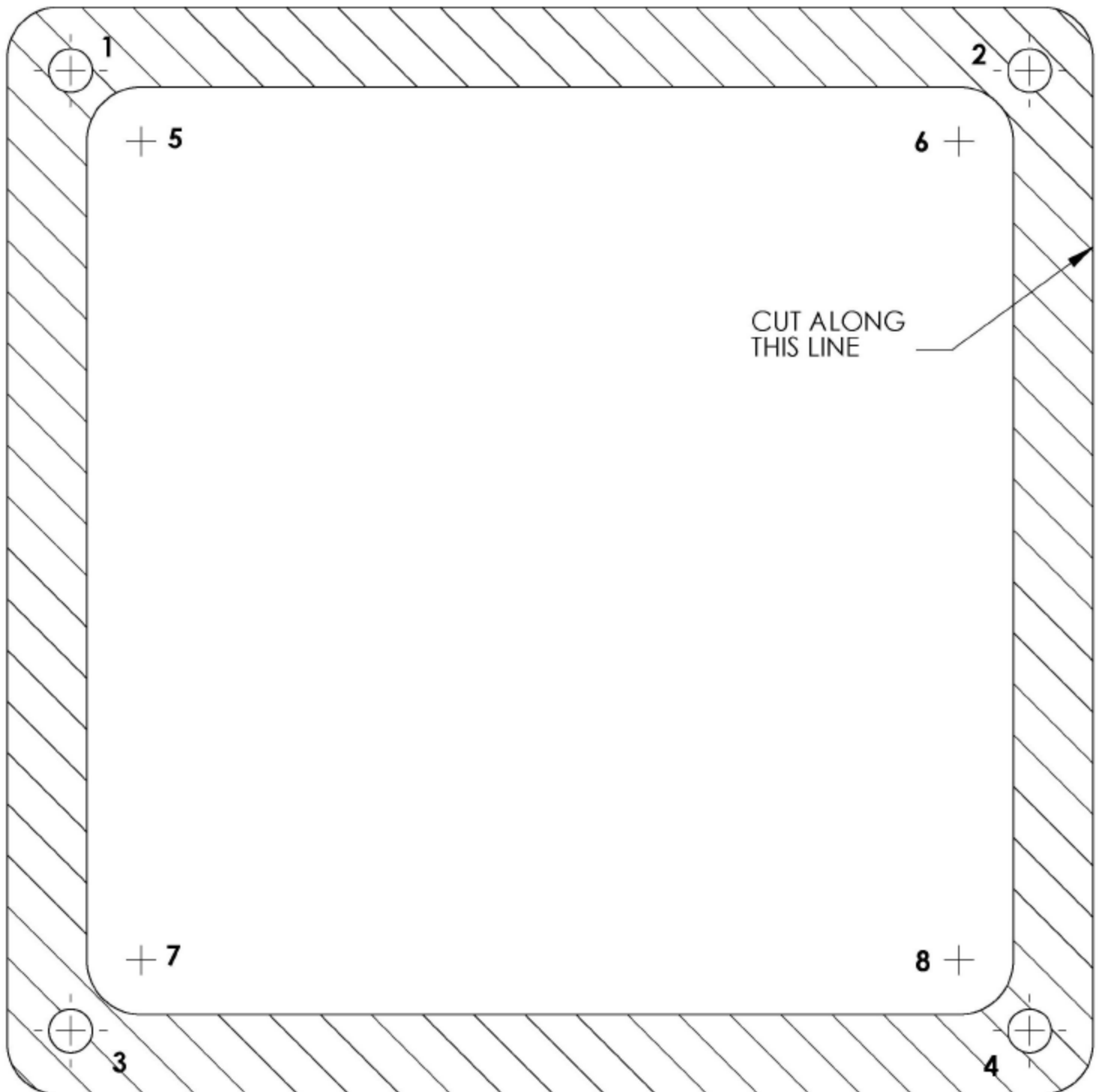

INSTRUCTIONS:

- 1) CUT THE TEMPLATE OUT WITH A PAIR OF SCISSORS ALONG THE NOTED LINE. TAPE THIS TEMPLATE TO THE TOP OF THE CONTROL PANEL AS FAR AWAY FROM THE MONITOR AS POSSIBLE, MAKING SURE THAT THE TRACKBALL WILL CLEAR THE CABINET BENEATH IT.
- 2) USING A SHARP OBJECT, MARK THE (8) POINTS SHOWN HERE ON THE CONTROL PANEL. USING A PENCIL, TRACE THE OUTSIDE OF THE TEMPLATE. REMOVE THE TEMPLATE.
- 3) DRILL HOLES 1-4 WITH THE 9/32" OR 5/16" DRILL BIT.
- 4) DRILL HOLES 5-8 WITH THE 3/4" DRILL BIT.
- 5) ROUTE THE CROSSHATCHED REGION TO A DEPTH OF ABOUT .075" (ABOUT THE THICKNESS OF A NICKEL).
- 6) USING THE SABRE SAW CUT OUT THE CENTER PORTION BY CUTTING BETWEEN HOLES 5-8.

BUTTON TEMPLATES

RIGHT BUTTON DRILL TEMPLATE

THE CENTER OF
BUTTON #1 SHOULD
BE LOCATED 2.75"
ABOVE, AND 8" TO
THE RIGHT OF THE
CENTER OF THE
TRACKBALL

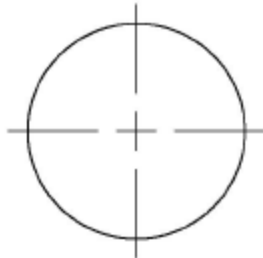

1

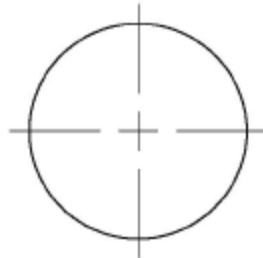

Cut Here to Use Both Templates

LEFT BUTTON DRILL TEMPLATE

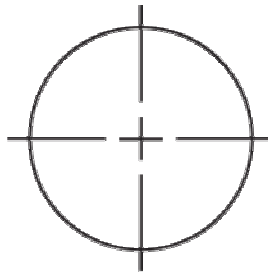

THE CENTER OF
BUTTON #2 SHOULD
BE LOCATED 3/4"
BELOW, AND 10 3/8" TO
THE LEFT OF THE
CENTER OF THE
TRACKBALL.

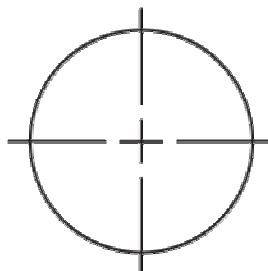

2

Contact Information

IT Sales and Service

To purchase additional Target Toss Pro: Bags machines or any of IT's other fine products please visit IT's website at www.itsgames.com!

General Numbers

Technical Support, Warranty, & Repair: Incredible Technologies, Inc.
847-870-7027 x 121

Parts, Customer Service, & Operator Services: Incredible Technologies, Inc.
847-870-7027 x 118

IT Sales Hotline
Incredible Technologies, Inc
847-870-7027 x 106
800-262-0323

IT Mailing Address:
Incredible Technologies, Inc.
3333 North Kennicott Avenue
Arlington Heights, IL 60004-0129

ITNet Registration/Sales Fax Number 847-454-9156

General/Tech Services Fax Number
847-870-0120

IT Vendor Information

Wells-Gardner:
Phone: 800-336-6630
Fax: 773-252-8299

Mars Technical Service:
Phone: 800-345-8172

Happ Controls:
Phone: 888-289 -4277

See Appendix C for replacement part numbers.



Incredible Technologies, Inc.
3333 N. Kennicott Ave.
Arlington Heights, IL 60004
Phone (847) 870-7027 Fax (847) 870-0120
www.itsgames.com

TARGET TOSS PRO: BAGS™, SILVER STRIKE BOWLING™, GOLDEN TEE LIVE®, ITS®, INCREDIBLE TECHNOLOGIES®, IT®, ITNet®, and IT incredible TECHNOLOGIES® are the properties of Incredible Technologies, Inc. All Rights Reserved.

© Copyright 2007-2008 Incredible Technologies, Inc. All Rights Reserved. Unauthorized duplication is a violation of applicable law.

All other marks are the properties of their respective owners. All rights reserved.