



Golden Tee PGA TOUR Edition Showpiece Commercial Full Kit Conversion Instructions

IMPORTANT – PLEASE READ

The conversion process requires removing the old electronic components and replacing them with the new components, including the following: System Box, I/O Board, Cabinet Identification Device (CID), Control Panel, Main Cable and USB Cabling.

The Card Reader is removed and replaced with a blanking plate, NFC replaces Card Reader functionality, and the 5" Touch Monitor replaces the Keypad.

If the current game does not have WiFi, a WiFi Dongle needs to be installed for a wireless connection that will allow access to online features. (A [WiFi Dongle Kit](#) can be purchased separately from IT.) Most games with WiFi access already have the dongle. If you don't have WiFi access, the game can be connected with an Ethernet cable.

IT highly recommends having two people available when removing and attaching the control panel.

NOTE: You must provide your own 4K TV. PGA TOUR is 4K Resolution Only.

Full Kit Conversion Contents

- Titan System Box
- I/O Board
- Cabinet Identification Device (CID)
- Fully Dressed Control Panel with Cabinet Cable
- Screw, 8-32x3/4" Hex-Head (4) – *Use to attach Fully Dressed Control Panel*
- Screw, 6x1" Slotted Hex (10) – *Use to attach I/O Board and CID*
- USB A Cable to 5 Pin - 3 Feet (2) - *Use to connect I/O Board and CID*
- 4K EDID Emulator – *Use to attach to the HDMI Port before the HDMI cable*
- AC Power Cord 18 Gage - 10 Feet
- Card Reader Blanking Plate
- Marquee PGA TOUR Edition
- Setup and Operation Guide

Tools/equipment required:

- ¼-inch Hex Nut Driver (No long than 9 inches for System Box only)
- 11/32-inch Nut Driver
- T15 Torx wrench with security
- Two pairs of small pliers
- Good lighting



Sections (Access any of the sections below by tapping on them)

Section 1: [Remove Nighthawk System Box](#)

Section 2: [Remove I/O Board](#)

Section 3: [Remove Cabinet Identification Device \(CID\)](#)

Section 4: [Disconnect and Remove Control Panel and Main Cable](#)

Section 5: [Disconnect and Remove Card Reader, Keypad and USB Cable](#)

Section 6: [Clean Cabinet of Remaining Debris](#)

Section 7: [Install I/O Board](#)

Section 8: [Install Cabinet Identification Device \(CID\)](#)

Section 9: [Install Titan System Box](#)

Section 10: [Attach and Connect Fully Dressed Control Panel](#)

Section 11: [Final Connections to System Box](#)

Section 12: [Install Marquee](#)

Reference Videos

All the videos referenced in the procedures can be found on the [IT Amusement – Instructions and Videos](http://amusement.itsgames.com/service/instructions) website (<http://amusement.itsgames.com/service/instructions>). Direct links to YouTube videos are provided in the procedures.



WARNINGS AND NOTICES – PLEASE READ BEFORE STARTING PROCEDURE

IMPORTANT SAFETY INSTRUCTIONS

- Read these instructions
- Keep these instructions
- Heed all warnings
- Follow all instructions
- Do not use this apparatus near water
- Clean only with dry cloth
- Do not block any ventilation openings. Install in accordance with the manufacturer's instructions.
- Do not install near any heat sources such as radiators, heat registers, stoves, or other apparatus (including amplifiers) that produce heat
- Do not defeat the safety purpose of the polarized or grounding-type plug. A polarized plug has two blades with one wider than the other. A grounding type plug has two blades and a third grounding prong. The wide blade or the third prong are provided for your safety. If the provided plug does not fit into your outlet, consult an electrician for replacement of the obsolete outlet.
- Protect the power cord from being walked on or pinched particularly at plugs, convenience receptacles, and the point where they exit from the apparatus.
- Only use attachments/accessories specified by the manufacturer.
- Unplug this apparatus during lightning storms or when unused for long periods of time.
- Refer all servicing to qualified service personnel. Servicing is required when the apparatus has been damaged in any way, such as power-supply cord or plug is damaged, liquid has been spilled or objects have fallen into the apparatus, the apparatus has been exposed to rain or moisture, does not operate normally, or has been dropped.
- DO NOT expose the apparatus to dripping and splashing. DO NOT put objects filled with liquids, such as vases on the apparatus.
- WARNING: To reduce the risk of fire or electric shock, do not expose this apparatus to rain or moisture.

CAUTION

The motherboard is provided with a replaceable lithium battery. There is a danger of explosion if a battery is incorrectly replaced. Replace the battery only with the same or equivalent type.

WARNING

The apparatus shall be connected to a mains socket outlet with a protective earthing connection. Substitute cords may not provide adequate fault protection. Only use the power cord supplied with this product or an Incredible Technologies, Inc. authorized replacement.

Electrostatic discharge (ESD) can damage components. Discharge yourself by touching the metal system box while your feet are flat on the ground before touching any components.

Section 1 – Remove Nighthawk System Box

1. Turn OFF game using the switch at the base of the cabinet And Disconnect the AC power cord from the back of the cabinet. Remove all connections to the System Box.
2. **Loosen** the six ¼” Hex-Head screws that secure the System Box. **Do not remove them.**
3. Carefully lift the System Box off the screws and up out of the cabinet and set aside the Nighthawk System Box.

Helpful YouTube Video

For a YouTube video, see [How to Remove and Install Your Nighthawk System Box](https://www.youtube.com/watch?v=e0Ej1QS_Id0&feature=youtu.be) (https://www.youtube.com/watch?v=e0Ej1QS_Id0&feature=youtu.be)

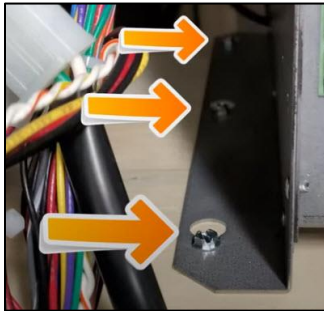

Hex Screw Loosening

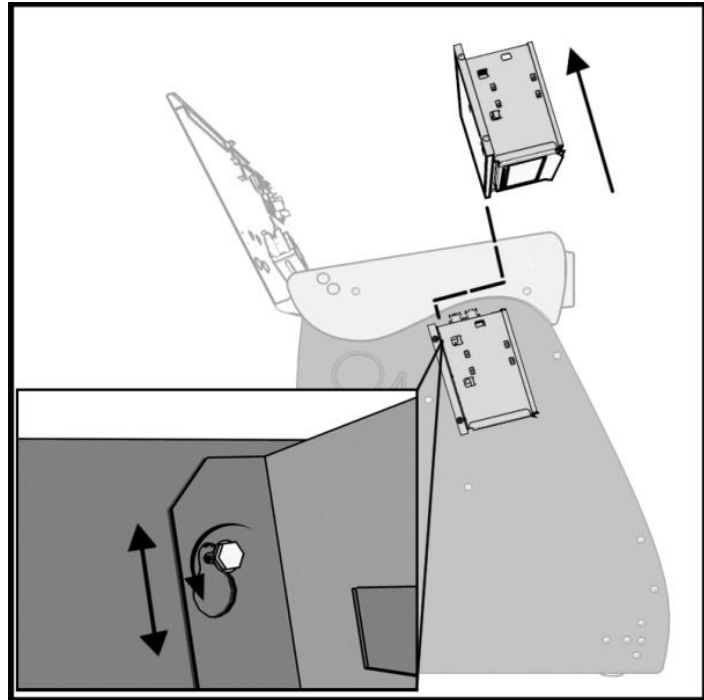

System Box Location

Section 2 –Remove I/O Board

1. Disconnect all of the cables connected to the I/O Board. Remove the old USB Cables. They will be replaced with the provided USB A to 5-pin Cables.
2. Using a ¼” Nut Driver unscrew the six screws holding the I/O Board to the cabinet.
3. Set aside the I/O Board and the six 6x1” Slotted Hex Screws. (New screws are provided for installation of the new board.)

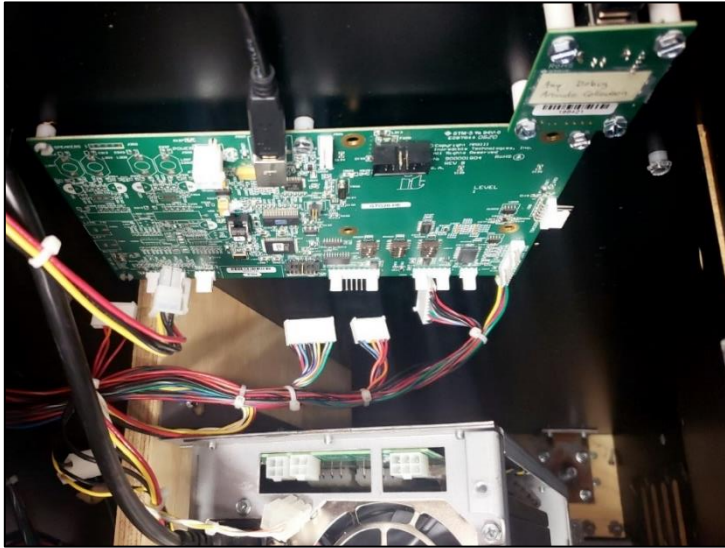

Disconnect all cables



Remove I/O Board

Helpful YouTube Video

For a YouTube video covering I/O Board removal, see [I/O Board Replacement Video](https://www.youtube.com/watch?v=aKNKLH7Yk0U) (<https://www.youtube.com/watch?v=aKNKLH7Yk0U>)

Section 3 – Remove Cabinet Identification Device (CID)

1. Disconnect the USB cable from the current game CID. Remove the old USB Cables. They will be replaced with the provided USB A to 5-pin Cables.
2. Loosen the four 6x1" Slotted Hex Screws that attach the CID to the cabinet and remove CID. (New screws are provided for installation of the new board.)



Section 4 – Disconnect and Remove Control Panel

1. Locate the 9-pin connector. This connector is on the Main Cable Harness routed to the left (facing the cabinet) coin vault cable opening. It will be located outside the vault behind the System Box wooden mounting board. Follow it to the terminal point and disconnect the 9-pin connector.

Note: The Main Cable Harness is a bundled collection of cables with various cable ties and pigtails. The Main Cable may have cable ties bundling it to other cable bundles. Carefully cut the cable ties where necessary taking care not to cut any wires.

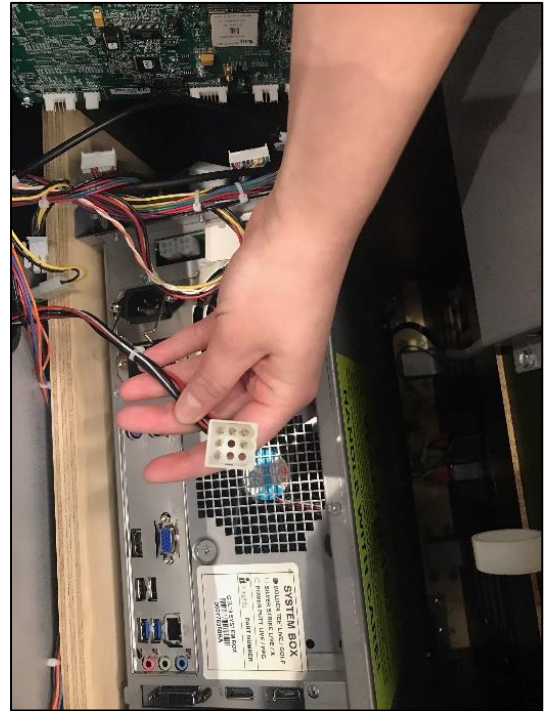

2. Disconnect the Service Panel Pigtail at the coin vault (two connectors to the red push buttons on the coin vault and one connector to the meter). Use the pliers to grab each connector to wiggle and pull apart. **Do not pull on the wires.**

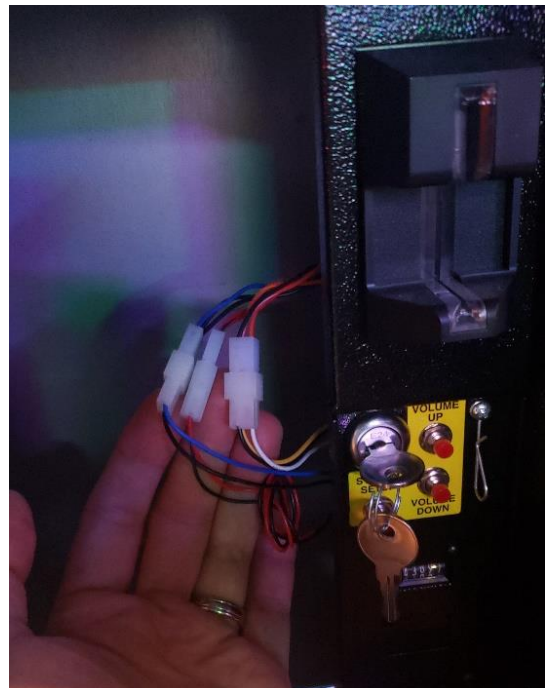

3. Disconnect the field ground wires at the trackball plate.
 - Remove two 11/32" nuts
 - Remove the first nut to remove the trackball ground giving access to the 11/32" nut securing the main field ground wire (the green/yellow wire).
 - Do not remove the main Green Yellow Grounding Wire from the cabinet. It must be reconnected to the new control panel.

Note: When disconnecting the field ground (green/yellow). Be sure to secure it to the cable clip on top of the Tray inside the cabinet.

DO NOT LET IT FALL TO THE BOTTOM OF THE CABINET. YOU WILL NEED TO RECONNECT IT LATER.

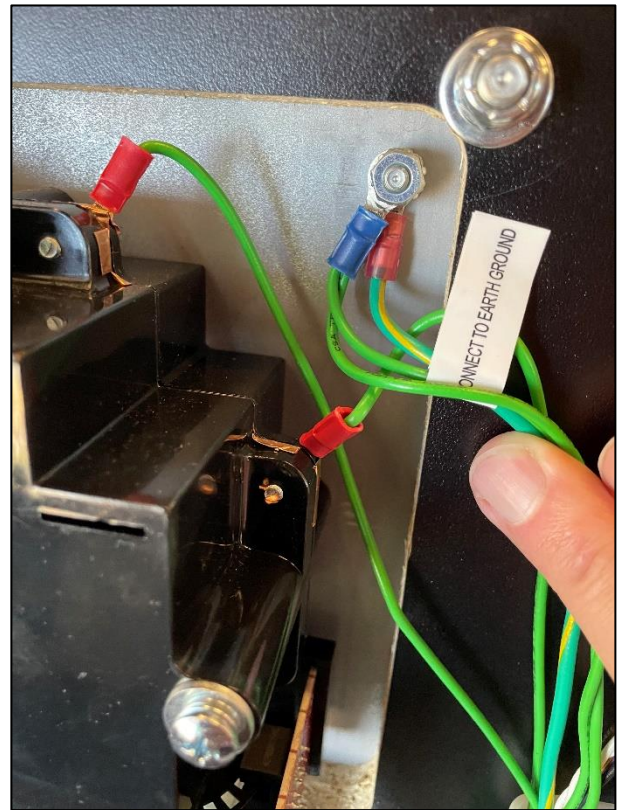

4. Locate three white cable clips and release the Main Cable Harness from the cable clips.



5. Remove Main Cable Harness from cabinet, coil and set aside. It will no longer be needed.

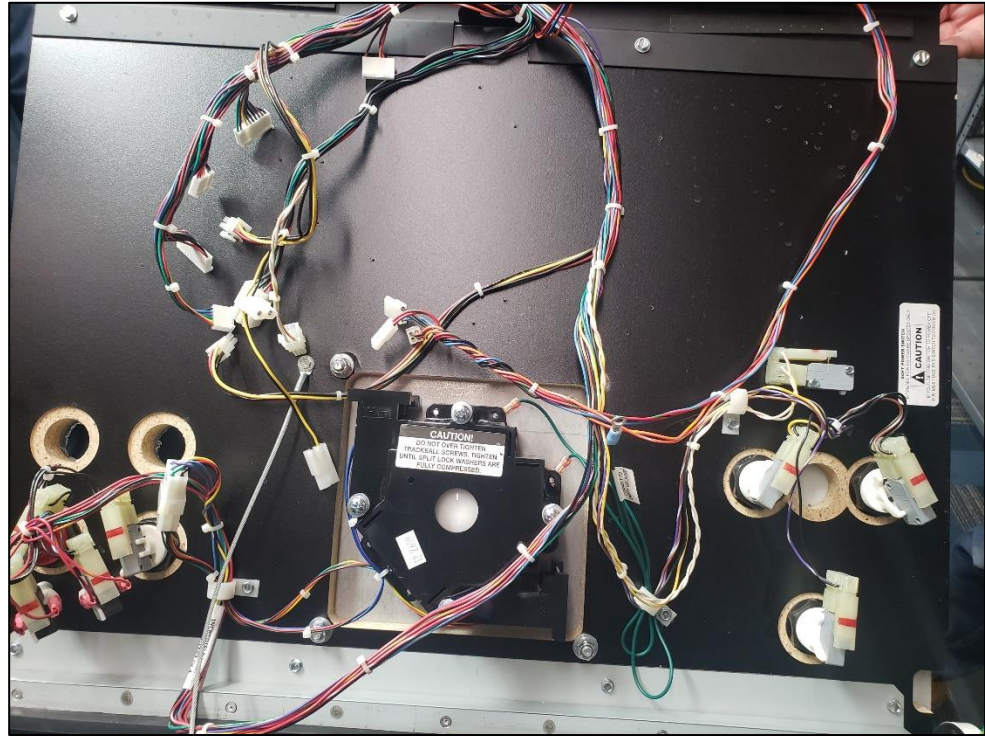

6. Remove one 1/4" Hex Head Screw that attaches the open limit cable from the cabinet. Save the screw to attach the new open limit when installing the new control panel.



7. Disconnect the Control Panel from the bumper hinge by removing the four ¼" Head Screws that attach the Control Panel to the cabinet. See four red circles in the image below. Set the Head Screws in a safe area. You will need them to attach the new Control Panel. Extra screws are also included with the kit.

WARNING: Be aware that after the four screws are removed, the Control Panel will be **completely** released. To prevent injury, it is helpful to have two people for this step.



DO NOT REMOVE THE FOLLOWING:

- Make sure to leave the HDMI Cable in place (if your game has an HDMI Cable).
- Make sure to leave the AC Power Cable in place.
- Make sure to leave the ground wire (green/yellow) in place.

Section 5 – Disconnect and Remove Card Reader, Keypad, and USB Cable

Remove Card Reader

Access the card reader through the coin door opening. To remove the card reader, disconnect the USB connector from the Card Reader. Then remove the 4 T-15 security screws that secure the mounting panel that holds the card reader, coin counter and buttons. Set the T-15 screws in a safe place. You will need them when installing the Blanking Plate. Reattach the Mounting panel to the coin door after removing the card reader and installing the blanking plate.

Next, remove the two Phillips head screws holding the card reader to the mounting panel. Once loose, pull the card reader out through the front of the panel.

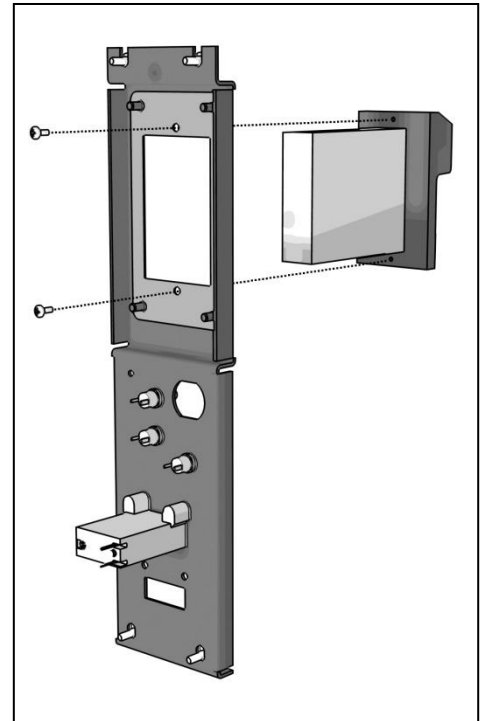

Attach Card Reader Blanking Plate

1. Using the 11/32" Hex Nut Driver, remove the four 8-32 Hex Nuts attaching the bezel to the mounting panel.
2. Using the same 8-32 Hex Nuts, attach the Blanking Plate in place of the Card Reader.
3. Attach the Panel to the vault using the four T-15 security screws removed during Section 5.

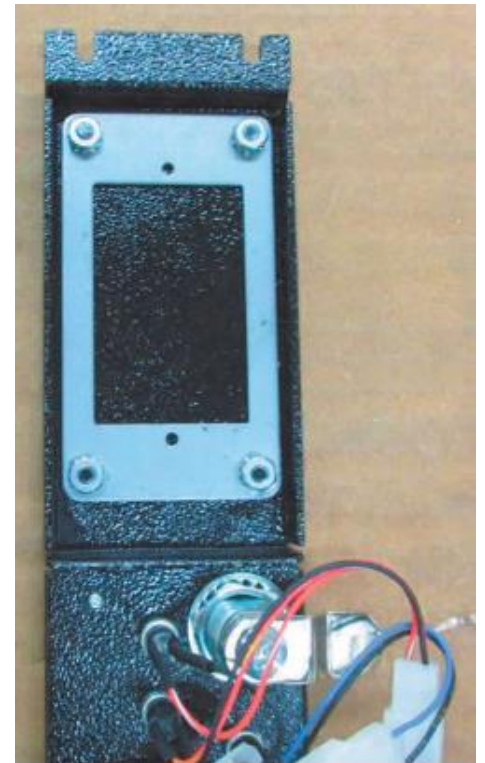



Remove Keypad

1. Remove two screws attaching the Keypad to the cabinet.
2. Remove the USB cable that connects it to the system box.
3. Remove the grounding wire where it connects.
4. Be sure all cables are removed.

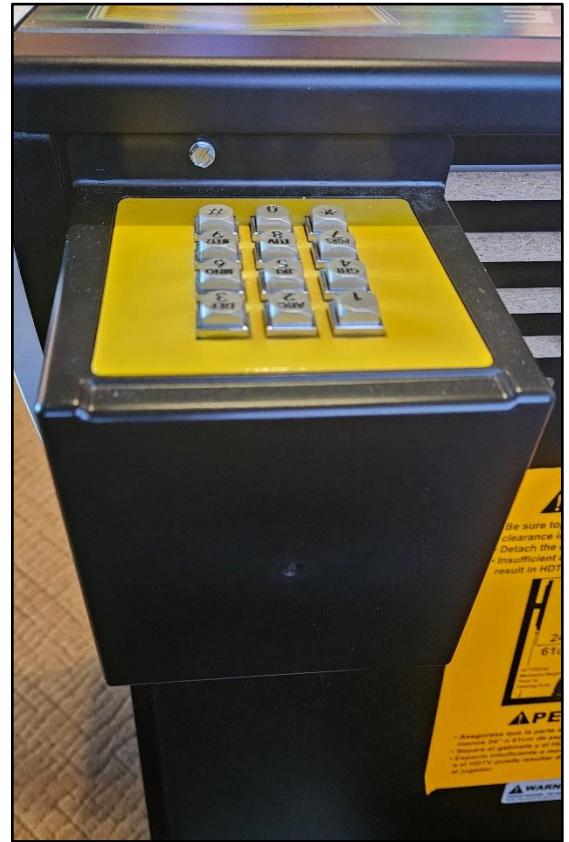

Section 6 – Clean Cabinet of Remaining Debris

A clean cabinet helps with the installation of the new electronics and performance of the new game. Remove any loose items that may have found their way into the cabinet over the years. Vacuum out any accumulated dust and debris from the bottom of the cabinet.

Section 7 – Install I/O Board

1. Using a ¼” Nut Driver attach the I/O Board to the cabinet with the six 6x1” Slotted Hex Screws.
2. Connect the USB A Cable to 5 Pin at J501 (This will connect to System Box USB panel – Black 2.0).

WARNING: DO NOT TRY TO REUSE THE OLD USB-A to USB-B CABLES

3. The cable should route under the Tray then back on top of the Tray and through Cable Clip 3. (See [Section 10](#) for details.)
4. See following page for CID installation.

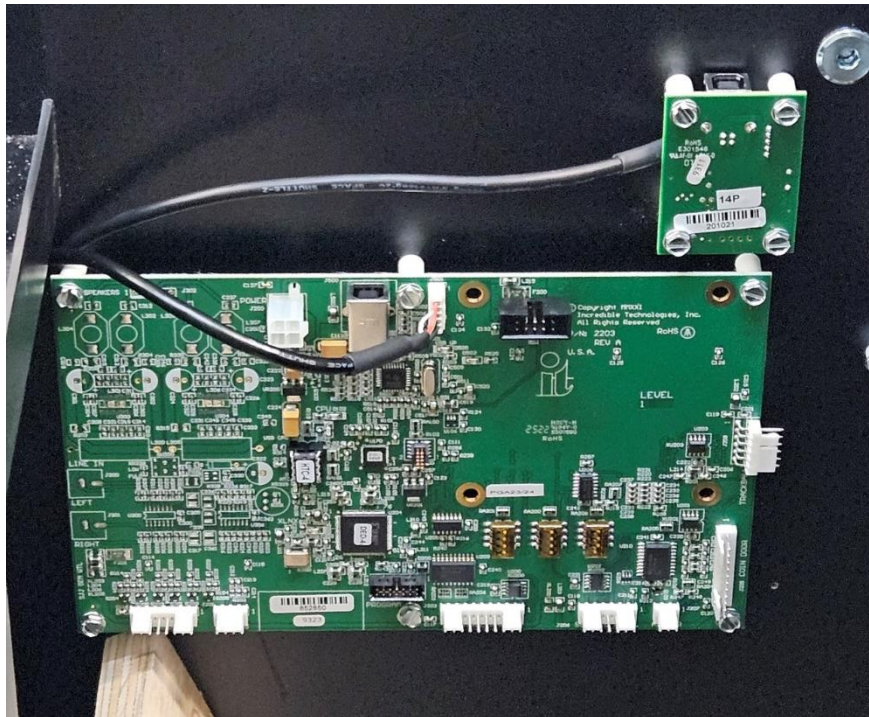

CID and I/O Board Installed

Helpful YouTube Video

For a YouTube video covering I/O Board replacement, see [I/O Board Replacement Video](#) (<https://www.youtube.com/watch?v=aKNKLH7Yk0U>)

Section 8 – Install Cabinet Identification Device (CID)

1. Connect the USB A Cable to 5 Pin to the Cabinet Identification Device. (This cable will connect to System Box USB panel – Black 2.0).

WARNING: DO NOT TRY TO REUSE THE OLD USB-A to USB-B CABLES.

2. Install the new CID to the cabinet using the four 6x1” Slotted Hex Screws.
3. The cable should tuck under the circuit board routed to the front of the cabinet. See CID and I/O Board Installed image on the previous page. The A Connector will route under the Tray then back on top of the Tray and through Cable Clip 3. (See [Section 10](#) for details.)

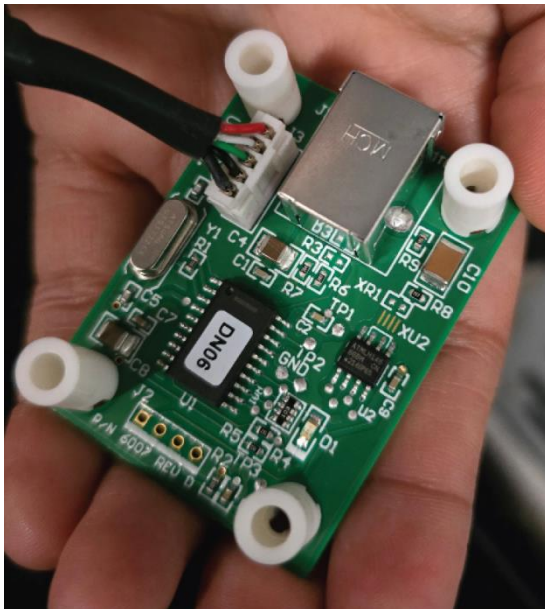

Connected CID

Attach the Cabinet Identification Number sticker over the old sticker on the back (side facing the monitor) of the Showpiece cabinet. See image in [Final Items](#).

Section 9 – Install Titan System Box

1. Align the Titan System Box onto the six mounting screws of the internal slanted panel. The Connection ports face up. Once the system box is in place, tighten the six ¼" Hex-Head screws to secure the System Box to the Panel.
2. Attach the EDID Emulator to the HDMI Port in the upper right corner of the rear of the System Box.
3. DO NOT reattach the cables at this point. (See [Section 11](#) for details.)

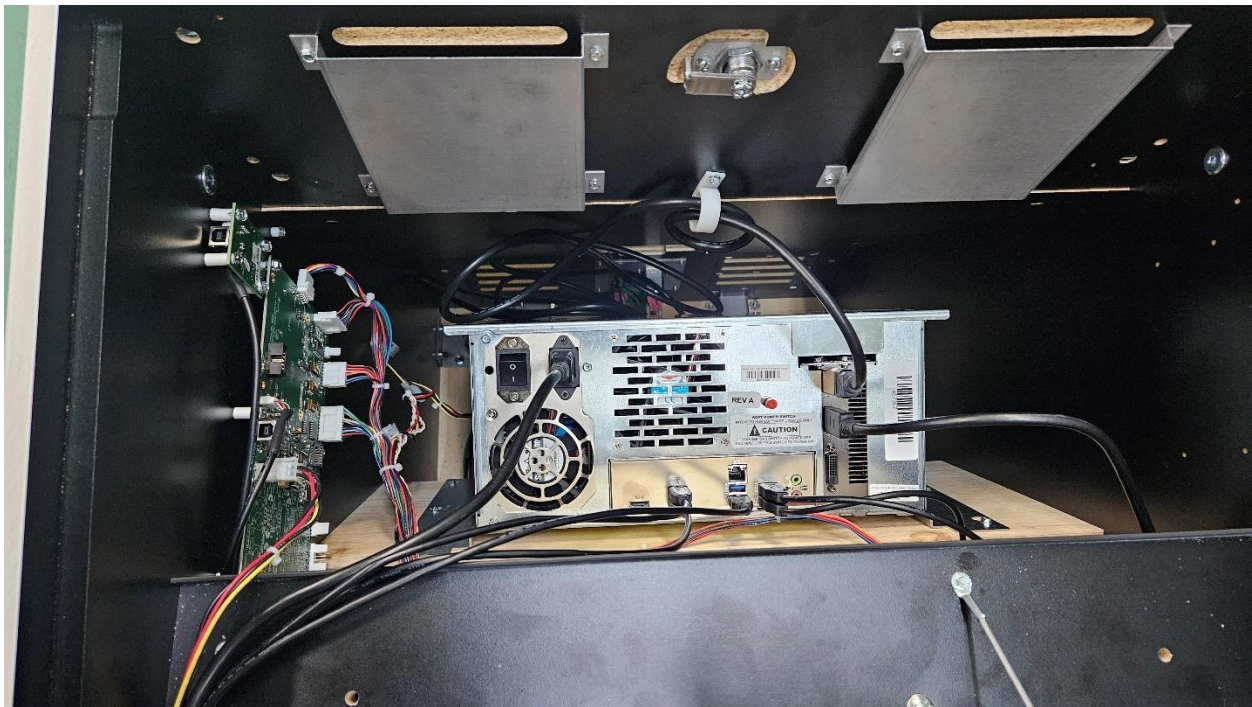

Titan System Box Location

Section 10 – Attach and Connect Fully Dressed Control Panel

1. Attach new Control Panel to the rubber hinge using four 8-32x3/4" Hex-Head Screws.
2. Reattach one 1/4" Hex-Head Screw connecting the open limit cable to the cabinet.
3. Reconnect the green/yellow field ground wire to the trackball plate and secure with the 11/32" nut. Attach the solid green wire from the trackball to the stud on the trackball plate and secure with the 11/32" nut.

Note: It is very important that field ground is reconnected to the new Control Panel Trackball plate.

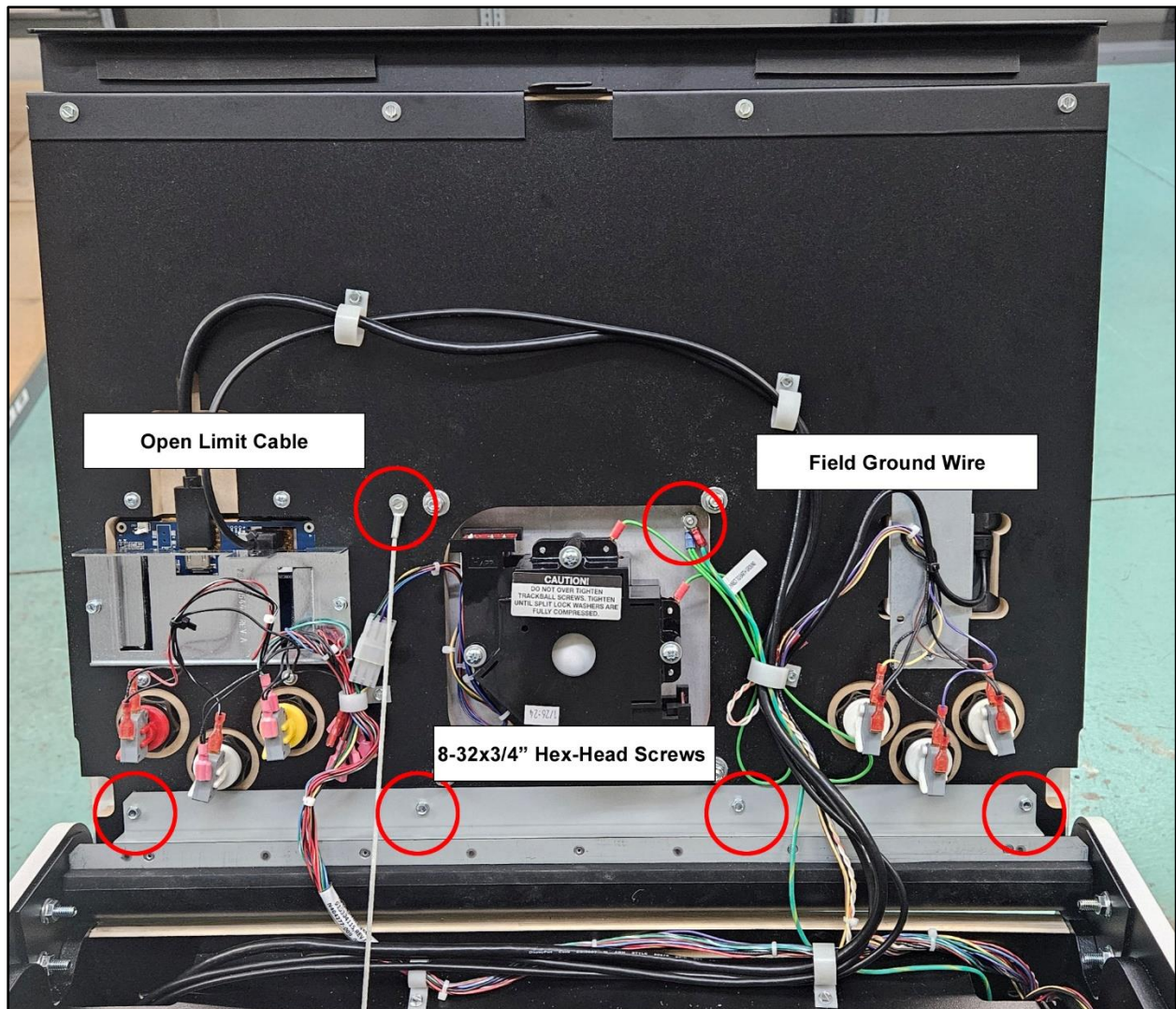

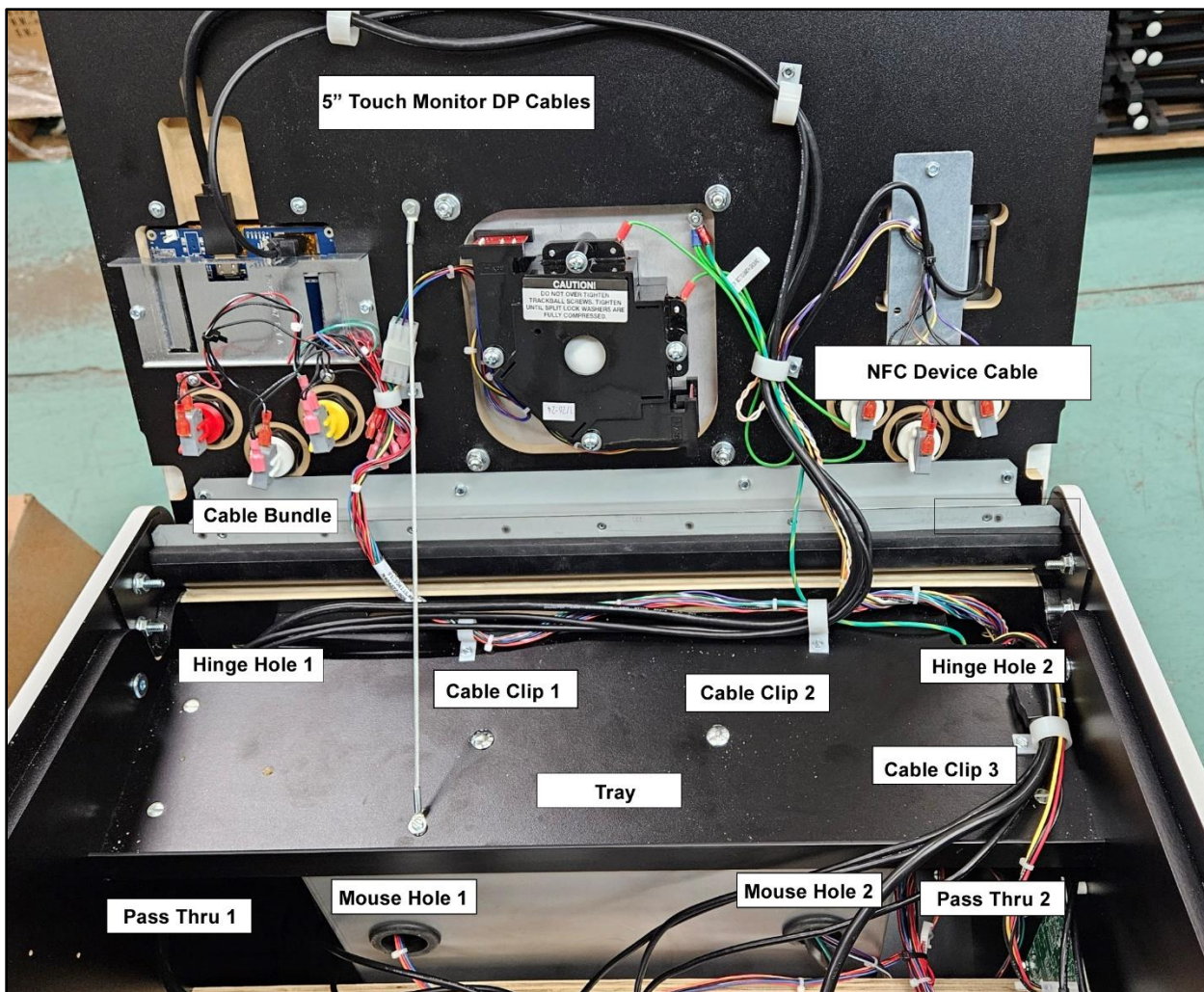

Use the image above for the following steps:

4. Guide the black **NFC Device Cable** and the black **5" Touch Monitor DP Cables** through **Cable Clip 2** and over **Cable Clip 1**. Drop those cables down into **Hinge Hole 1** and pull through **Pass Thru 1** toward the System Box.
5. Guide the **Cable Bundle** through **Cable Clip 1** and **Cable Clip 2**. Separate the I/O Power Cable (Red/Yellow/Black) from the Bundle and drape over the top of the **Tray**. Secure with **Cable Clip 3**.
6. Drop the rest of the **Cable Bundle** down into **Hinge Hole 2** and pull through **Pass Thru 2**.
7. Connect the 9-pin Connector from **Mouse Hole 2** to the 9-pin Connector on the Cable Bundle. (See image at right.)

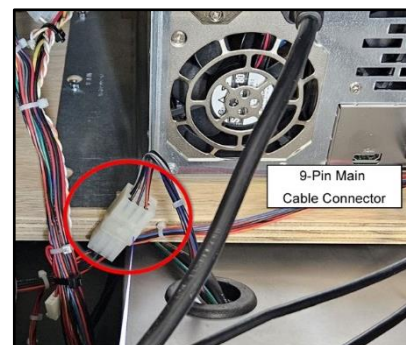

8. Feed the three pigtail service connections through **Mouse Hole 1** into the vault. Connect the three pigtails to the service connections on the service panel. Connect the meter and red push button connectors on the coin vault and one connector to the meter.

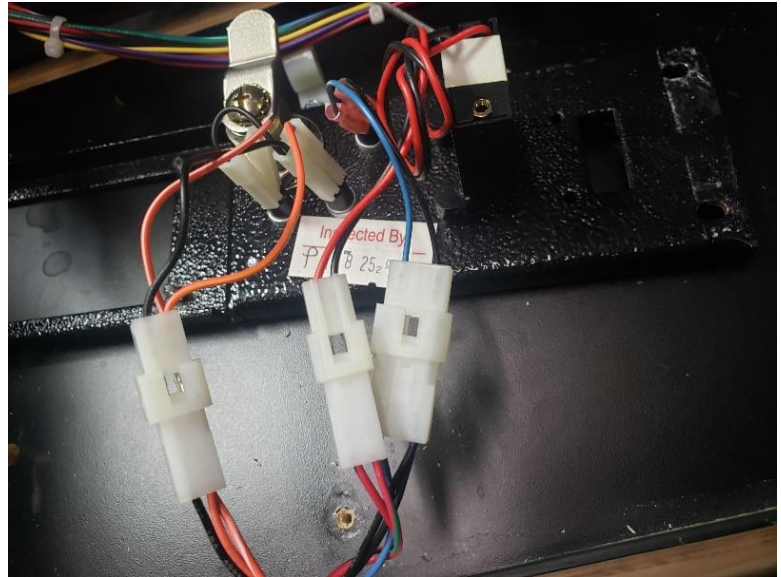

I/O Board Connections

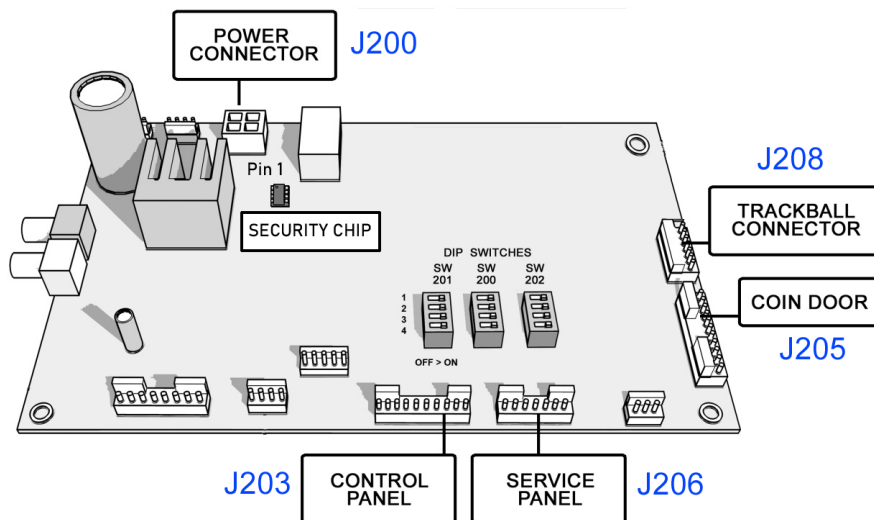

Clockwise Connections when facing I/O Board

- 4 pin I/O Board Power Connector (Red/Yellow/Black) (J200) – Over the Tray
- 6 pin Trackball Connector (J208) – Under the Tray
- 11 pin Coin Door Connector (J205) – Under the Tray
- 7 pin Service Panel Connector (J206) – Under the Tray
- 10 pin Control Panel Connector (J203) – Under the Tray

Note: If you have a lighted marquee, use the two-prong Yellow and Black wire connector in the bundle to connect it.

Note: Clip any remaining cables through **Cable Clip 3**.



Final Connections with System Box Installed

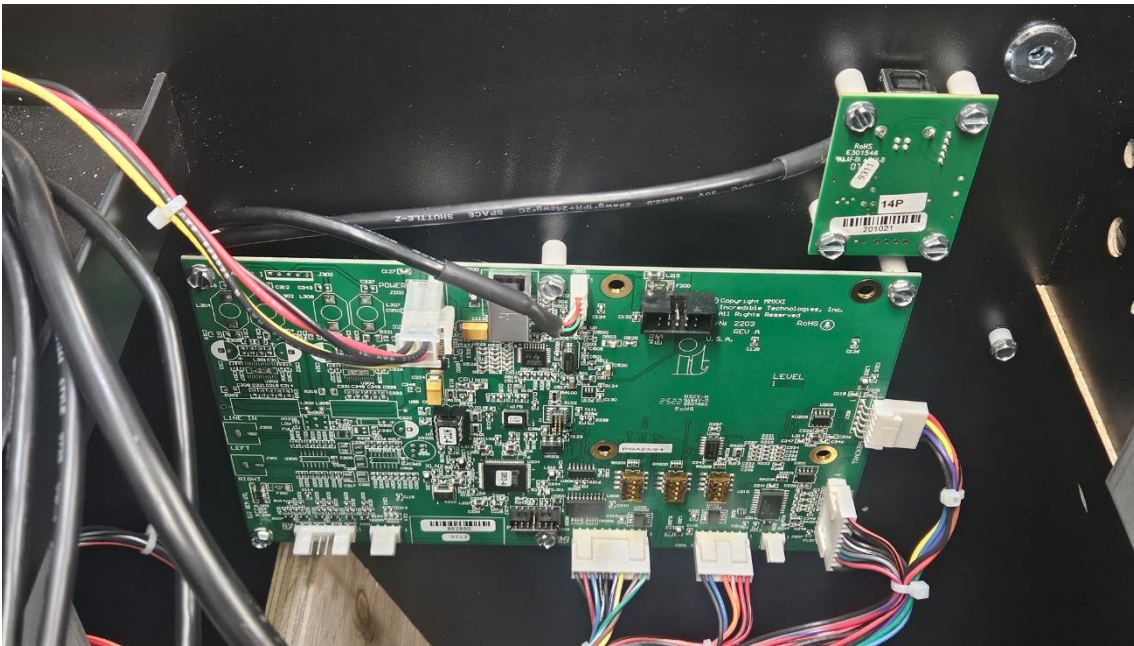

Final Connections with I/O Board and CID Installed

Section 11 - Final Connections to the System Box

Power Connections

- Connect 4-pin I/O Power Connector (J200) to the side of the System Box.
- Plug in the AC Power Cable to the System Box.

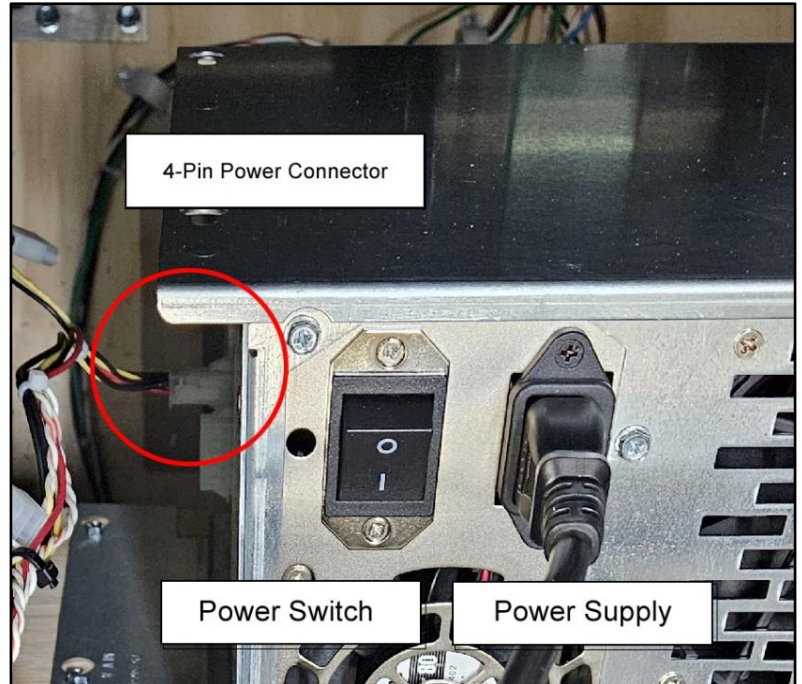

USB Connections

Make the following USB Connections to the System Box:

- I/O Board J501 to System Box – Black 2.0
- CID to System Box – Black 2.0 port
- [WiFi Dongle Cable](#) (not included) to System Box – Blue 3.0 (Left Port)
- NFC Device to System Box – Blue 3.0 (Right Port)
- 5" Touch Monitor to System Box – Blue 3.0 (Right Port)

Note: Leave one Blue 3.0 USB port open for software updates.

IGNORE THE HDMI PORT ON THE FAR LEFT OF THE CID AND I/O BOARD PORTS.

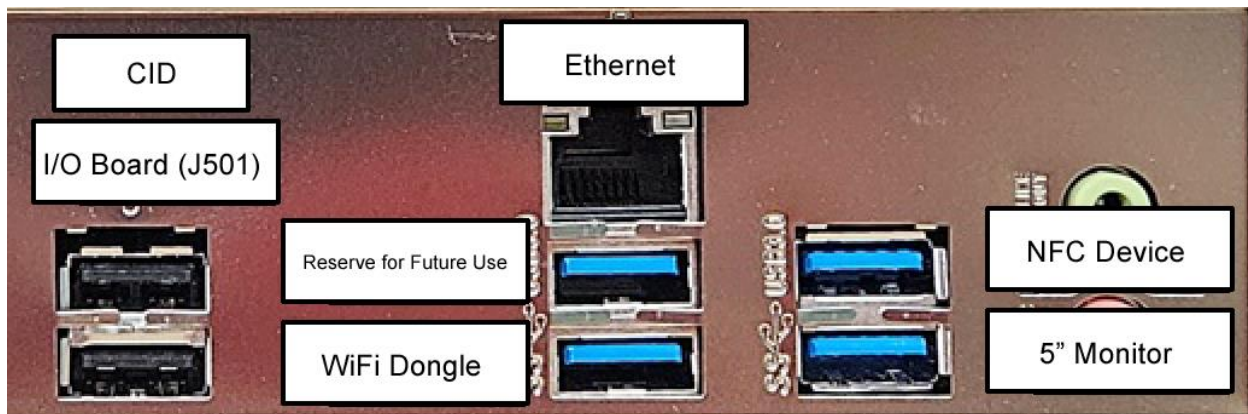

Video Connections 4K TV

Golden Tee PGA TOUR Edition **only** supports 4K resolution. Do not attempt to connect a monitor with less than 4K resolution to the PGA TOUR Edition.

FOR A PROPER VIDEO RELAY FEED, IT IS IMPORTANT TO HAVE THE EDID EMULATOR ATTACHED TO THE HDMI PORT.

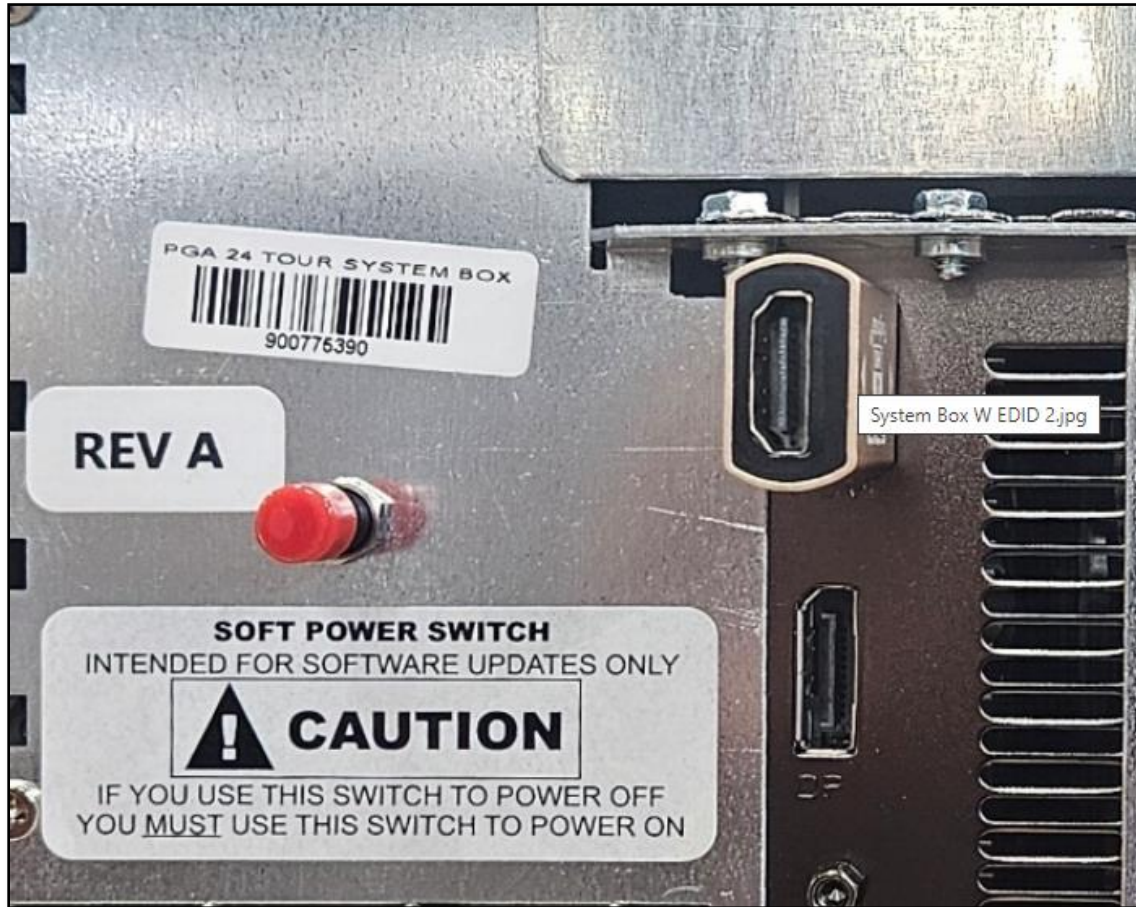

EDID Attached

WiFi Dongle

NOTE: For WiFi to work, a WiFi Dongle Must Be installed. This is the Dongle Part Number and Name: 760365301K WIFI ADAPTER KIT (TITAN). Use this when ordering. Phone Number to place order: 1-847-870-7027 Extension 386.

For purchase outside IT: ONLY USE THESE MODELS:

- Edimax Model EW-7822ULC
- ASUS Model USB-AC51.

Video Connections 4K TV

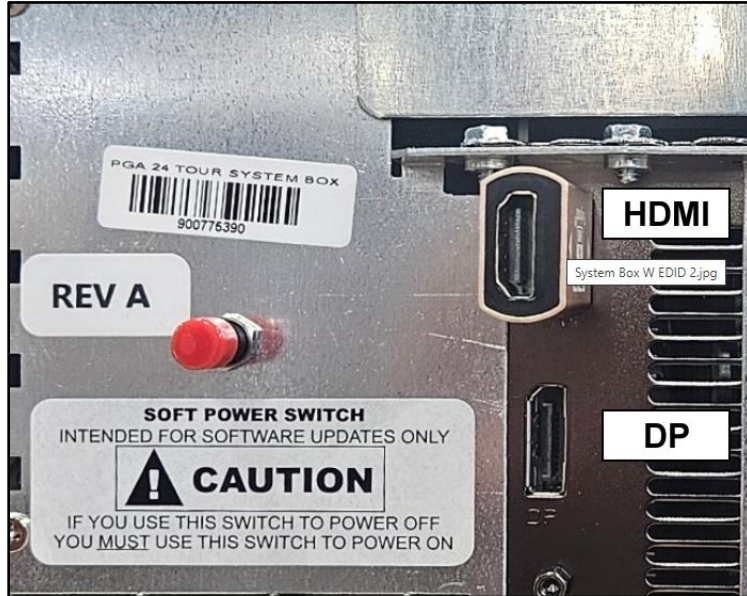

Main Monitor HDMI Connection

Connect the HDMI cable (not included) to the EDID Emulator Attached to the HDMI Video Output Port on the System Box.

DP Cable

Connect the DP Cable from the 5" Touch Monitor to the System Box Display Port Video Output.



DO NOT USE

Do not use the port below the DP Port for any reason.

Video Connections

Connect the Main Video HDMI cable to the TV HDMI Video input port you select. Find Source on the television remote control and select the HDMI port where the cable is attached.

Check All Connections

Go over your entire cabinet again and double-check all the connections. Make sure that all connectors are tight and secure and in their proper place. Look for frayed, broken or exposed wiring and repair as needed. Bundle and cable-tie wiring and secure it to the inside of the cabinet. A thorough and neat job now will save you a lot of time and trouble in the future.

- Close Control Panel. Be careful not to pinch any fingers.
- Reattach power cable at the back of the cabinet and power ON the cabinet.
- Click on the image below to be directed to the [PGA TOUR](https://www.pgatour.com) website. There you can learn about using the NFC feature, Club Pass, Online Features and so much more!





Section 12 – Install Marquee

Included with your Golden Tee LIVE kit is a new marquee. This will help identify your new game as Golden Tee LIVE. By placing and installing it correctly, it can help give players instant recognition, even from a distance.

Marquee Installation



1. Slide the rectangular marquee mounting frame from its position on the two upright posts.
2. Remove any one of the four side pieces of the mounting frame.
3. Remove the current plastic laminate marquee from the mounting frame, but do not remove the cardboard.
4. Slide the updated marquee into place and reassemble the side piece or pieces. Make sure all of the surrounding pieces of the mounting frame are tight and the plastic laminate is smooth against the cardboard.
5. Slide the fully assembled marquee back into position.

To power a lighted Marquee a 4 pin to 6 pin adapter is required:

The Adapter Part Number is:
915304214 CABLE ASSY,
MARQUEE PWR ADAPTER,
TITAN, SHOWPIECE.

With the adapter, connect the lighted marquee to the 6 pin 12 volt power connector on the side of the system box





Final Items

Make sure the Cabinet Identification Number sticker has been placed over the old sticker on the back (side facing the monitor) of the Showpiece cabinet:



Store the Setup and Operation Guide in the plastic bag at the back of the vault for future reference:

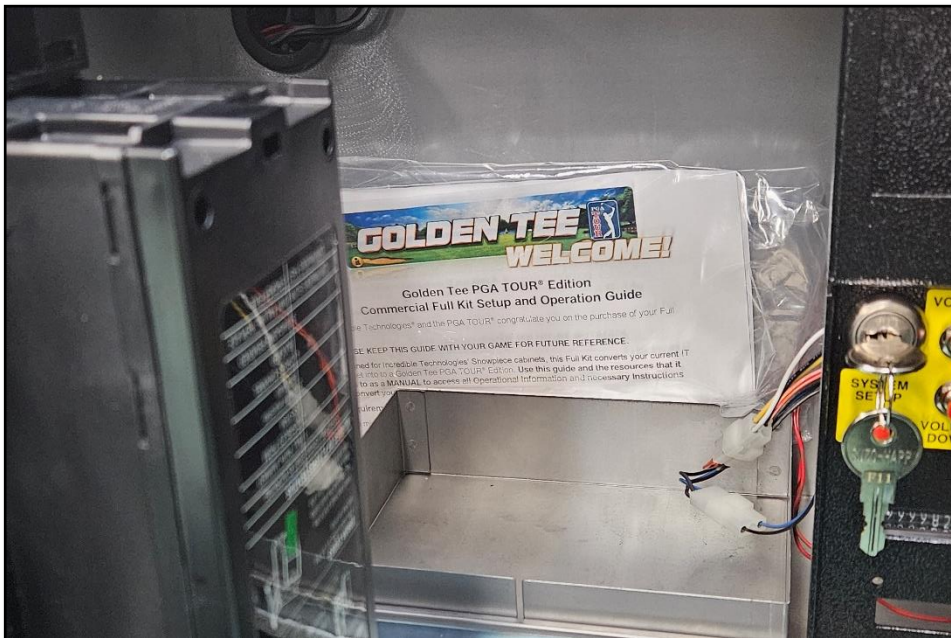



Getting Online for the Ultimate Player Experience

To take full advantage of all the incredible content in PGA TOUR Edition, connect your game to the location's network and self-register your game using your ITNET Operator Account information. This will unleash the online features and increase earnings!

Note: Country Code Numbers: USA IS 000 / Canada is 003.



Scan for detailed instructions to bring your game online: [PGA TOUR Commercial Online Configuration Guide \(PDF 338 KB\)](#)

https://amusement.itsgames.com/pga_commercial_online_config

Troubleshooting and Frequently Asked Questions (FAQ) Guide

Scan for the [Golden Tee PGA TOUR Edition Troubleshooting and FAQ \(PDF 524 KB\)](#)

https://amusement.itsgames.com/pga_commercial_troubleshooting_faq



Additional Resources



Operator Menus and Game Operation Guide

Scan for questions about the Operator Menus, Collections and Game Operation: Golden Tee [PGA TOUR Edition Operator Menus and Game Operation Guide \(PDF 4.2 MB\)](#)

https://amusement.itsgames.com/pga_commercial_menus_operation_guide

Additional Service Questions

For help with any additional questions, visit the Resources area of the Golden Tee PGA TOUR website:

<https://amusement.itsgames.com/games/golden-tee-pga-tour/>





Input/Output Connections (I/O Power, Trackball, etc.)

For All PGA TOUR Edition Kits

Trackball Harness Connector Pin Outs

I/O Board Connector	Trackball Connector
PIN WIRE #6 – Black	PIN WIRE #1 – Black
PIN WIRE #1 – Red	PIN WIRE #2 – Red
PIN WIRE #2 – Yellow	PIN WIRE #3 – Yellow
PIN WIRE #3 – Green	PIN WIRE #4 – Green
PIN WIRE #5 – Blue	PIN WIRE #5 – Blue
PIN WIRE #4 – Purple	PIN WIRE #6 – Purple

I/O Power Cable Pin Outs

Pin Number	Wire Color	Function
1	Yellow	+ 12 Volts DC
2	Black	Ground
3	Red	+ 5 Volts DC
4	Black	Ground

Control Panel J203 Connector Pin Outs

Pin	Color	Function
1	Green-White	Options
2	Brown-White	Left
3		No Connection
4	Yellow-White	Right
5	Violet-White	Overhead View (Fillyby)
6	Black	Volume GND
7	Black-White	Spin
8		No Connection
9	Red-White	Start (Red Button)
10	Black	Ground



Input/Output Connections (I/O Power, Trackball, etc.)

Coin Door J205

Pin	Color	Function
1	Red-Black	Lamp Power - Coin
2	Black	Lamp Ground - Coin
3		No Connection
4	Black	Bill Ground
5	Grey-White	Bill
6		No Connection
7		No Connection
8		No Connection
9	Red-Blue	Coin 1
10		No Connection
11	Black	Coin Ground

Service Panel J206

Pin	Color	Function
1	Red-Black	Meter Power
2	Red-Green	Coin Meter
3	Orange-White	Volume Up
4	Orange-Yellow	Volume Down
5		No Connection
6	Blue	Service Button
7	Black	Test Ground